

SYMBOLS_

PACKAGING TYPE_

Shows the various packaging types available



Single carton



Self Service pack to hang and display

SWOP-PAD REPLACEMENT PAD COLOURS_

Shows the replacement pad colours available



INTERNET SERVICES_

Having a presence and selling on the Internet are becoming more and more important. Trodat's professional Internet services are there to support you.

You can find more information on: **www.uTypia.com**

ADVERTISING MATERIAL_

Please, refer to pages 54-55 in our catalogue to review the current POS materials.

To see details of available advertising and promotional material, such as catalogues, folders, posters, stickers, merchandising items, displays, etc. please refer to the PDF-file which can be downloaded from our Internet site:

www.trodat.net (go to: **TRADING PARTNERS/SERVICES/ADVERTISING MATERIALS**)

MEDIA-SERVICE (IMAGE DATABASE)_

In response to increased market demand and customer requirements for more graphics and promotional materials, we now have a special service: the graphical images database. Download graphics and much more direct from our website!

Visit our website: **www.trodat.net**

CONTENTS_

| | | |
|-------|-------|--|
| 06-08 | | TRODAT MULTI COLOR IMPRESSION_ The first individual stamp that makes an impression in four colours. |
| 09-15 | | TRODAT PROFESSIONAL LINE_ Text stamps, daters, daters + text, numberers and dial-a-phrase stamps |
| 16-24 | | TRODAT PRINTY LINE_ Text stamps, daters, daters + text, numberers and dial-a-phrase stamps |
| 25-28 | | TRODAT TYPOMATIC LINE_ Do-it-yourself text stamps, Daters with D.I.Y. text, and spare parts for typomatic stamps |
| 29-31 | | TRODAT SWOP-PAD REPLACEMENT PADS_ Replacement pads for Printy Line, Professional Line and self-inking stamps (old) |
| 32-36 | | TRODAT IMPRESSOR PRE-INKED_ Mounts and accessories |
| 37-45 | | TRODAT CLASSIC LINE_ Daters, daters + text, numberers and dial-a-phrase stamps |
| 46-47 | | TRODAT TWIN_ Ball-point pen stamps |
| 48-49 | | TRODAT MOBILE MARKER_ Pocket stamp in mini format |
| 50 | | TRODAT STOCK STAMPS_ Office Printy, Stamp Stack |
| 51 | | TRODAT SPECIAL STAMPS_ Clothing Marker, Printy 4910 with key ring, Vienna Pocket Stamp, pocket seals, automatic numbering machines |
| 52 | | TRODAT ACCESSORIES_ Stamp pads, inks, stamp racks, laser rubber |
| 54-55 | | TRODAT ADVERTISING MATERIAL_ |
| 56-57 | | PACKAGING OVERVIEW_ |
| 58-59 | | uTypia_ Internet Services |
| 60-61 | | TRODAT DIGITAL SEALING_ |
| 62 | | TROTEC LASER TECHNOLOGY_ |



TRODAT MULTI COLOR IMPRESSION_

THE FIRST INDIVIDUAL STAMP THAT MAKES AN IMPRESSION IN FOUR COLOURS_



Trodat now has something that others do not have.

Multi-Color-Impression – the first colour stamp available right now for many Trodat models. The four colours can be individually combined in any way you like. The owner leaves a unique and lasting impression.

We are particularly pleased that this innovation will make the world a little bit more colourful and friendly.

BINARY DIGITS INC.

■ professional IT solutions
■ 66 Futuredrive
■ Silicon Valley
■ California, USA



BINARY DIGITS INC.

■ professional IT solutions
■ 66 Futuredrive
■ Silicon Valley
■ California, USA

THE ADVANTAGES AT A GLANCE_

- A choice of 4 different colours for your impression



- Customised impression: colour fields can be freely selected
- Top quality impression: a perfect impression you have come to expect from Trodat stamps, together with a lifetime guarantee



MORE COLOUR FOR YOUR STAMP_

Trodat provides a stamp impression with more colour, structuring it precisely in individual colour fields. You can emphasise your logo, company name, new telephone number and information in colour and stand out from your competitors.

IMPRESSION SAMPLES_

Ristorante Trattoria

~ Da Vinci ~

VIA BRERA 4, MILANO
Tel. (02) 633 08 546
Fax (02) 633 08 546-12



COPERNIC 22 8021
Barcelona Fax. 932 001 782
Tlf. 932 001 783
CLÍNICA SAN ROQUE



Alpen Apotheke

Linzer Straße 124, A-4600 Wels
Tel. 0 72 42 / 26 31, Fax 0 72 42 / 26 32
Öffnungszeiten:
Mo-Fr 8:00-18:00, Sa 8:00-12:00

Café Vis à Vis

Resto'Lounge & Coffee bar

☕ 24 AVR 2010 ☕

Angle – 6, Place de la Republique, 75011 Paris
Tel. 01 47 00 44 10, Fax 01 47 00 44 11
www.cofevisavis.fr

Bibliothèque

Au coin de la sagesse



5 rue des Vieux Moulins
77100 Meaux
Tél. 01 63 32 52 14
Fax 01 63 32 52 12

SEGURO SOCIAL
SECCION CAJA Y CUSTODIA DE VALORES
CANCELADO

15 JUN 2010

LEON QUESADA ARNOLDO
CAJERO No 14



PIERRE MAURIOS

ARCHITECTE D.L.P.G

30 rue de Paris
94000 Vincennes
Tél. 01 45 62 87 89

Urbanisme □ Architecture □ Design



Aikou Surf Shop

345 Willow Rd, La Grange, IL 60032
P: (800) 555-8932 F:(800) 555-8944



Bäckerei Bräuer

Hofwiese12, 90204 Nürnberg,
Tel. 0911 / 123 443

Weizen aus biologischem Anbau



Swim Wear

P: (800) 555-8944
345 Willow Rd., IL 60032



International Bank Limited

Vossiusstr 3, 1071AB Amsterdam
Tel. 020-141516
Fax 020-141516-17
www.banklimited.nl

Nederland NV



HIGH TECH FOR MORE COLOUR_

MULTI COLOR IMPRESSION is based on a high tech and patent-pending production process ranging from precise cutting between the colour fields to the best possible pad-inking. The whole design focusses on a top-quality impression for the customer.

This technology is supplied by Trotec, part of the Trodat Group. The specialist knowledge comes from Trodat and the stamp makers.

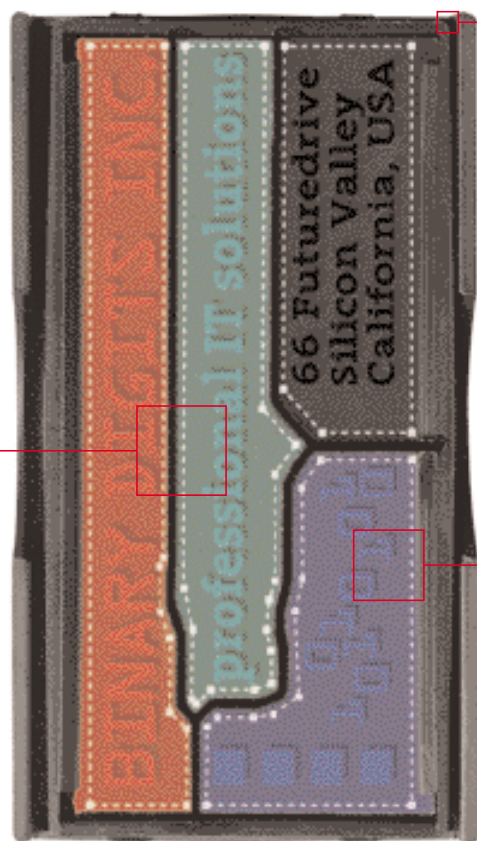

TAILOR-MADE COLOUR FIELDS_

In order to tailor-make the impression to the customers' needs, the colour fields can be arranged in any way on the pad.

TRODAT MULTI COLOR IMPRESSION provides you with a high degree of independent design. The only limitations are that there must be a space of at least 2.5mm between the letters or characters in the different colour fields and that the minimum size of any colour field must be 8mm x 8mm. Using the layout of the text on the stamp, the TROTEC software calculates the best possible contours of the colour fields.

PRECISE CUTTING_

Laser technology from TROTEC, a company of the TRODAT Group. A laser beam accurately cuts the specially processed pad material to within a tenth of a millimetre.

These precise high-tech cuts separate and seal the different colour fields.

PERFECT INK DOSAGE_

In order to ink the colour fields accurately with original Trodat inks, special ink injectors have been developed to dispense the correct amount of ink accurately to within a tenth of a millimetre by using special software. The result is a beautiful Trodat-quality stamp impression.



RE-ORDERING IS EASY_

Original Multi Color pads for individual multi-colour stamps are quick and easy to order.

MULTI COLOR IMPRESSION COMPATIBLE STAMPS_

• TRODAT PRINTY LINE_

All Printy NEW text stamps from size 4912 and above (circular stamps from size 46030 and above) and the NEW Printy dater + text

• TRODAT PROFESSIONAL LINE_

All Professional Line text stamps, daters + text, numberers + text



TRODAT PROFESSIONAL LINE_

QUALITY WITHOUT COMPROMISE_

Whether you are working at a counter or in an office, the Trodat Professional Line is the best choice for self-inking stamps. Ideal for multiple stamp users, their strong point is that they are reliable, clean and easy to use.

The standard for the Trodat Professional Line is uncompromising quality: robust steel core and top quality plastic, strict quality control for the finish and ergonomic design.

THE HANDLE_

ergonomically designed

THE TWO-WAY LOCKING MECHANISM TO FACILITATE_

- daily date changing
- pad-changing

THE PLASTIC FRAME_

Twice the usual lifetime thanks to the use of a new and even sturdier plastic alloy.

THE SHOCK ABSORBER_

Stable and well balanced, quiet stamp action

THE STEEL CORE_

Sturdy construction for repetitive stamping

INDEX WINDOW_

Shows the full stamp text in the original size



GENEROUS DIMENSIONS_

The small size of the date slot in the dater and numberer models allows you more space to set your customised textplate.

THE STABLE STEEL POSITIONING FRAME_

So that you can position the stamp accurately

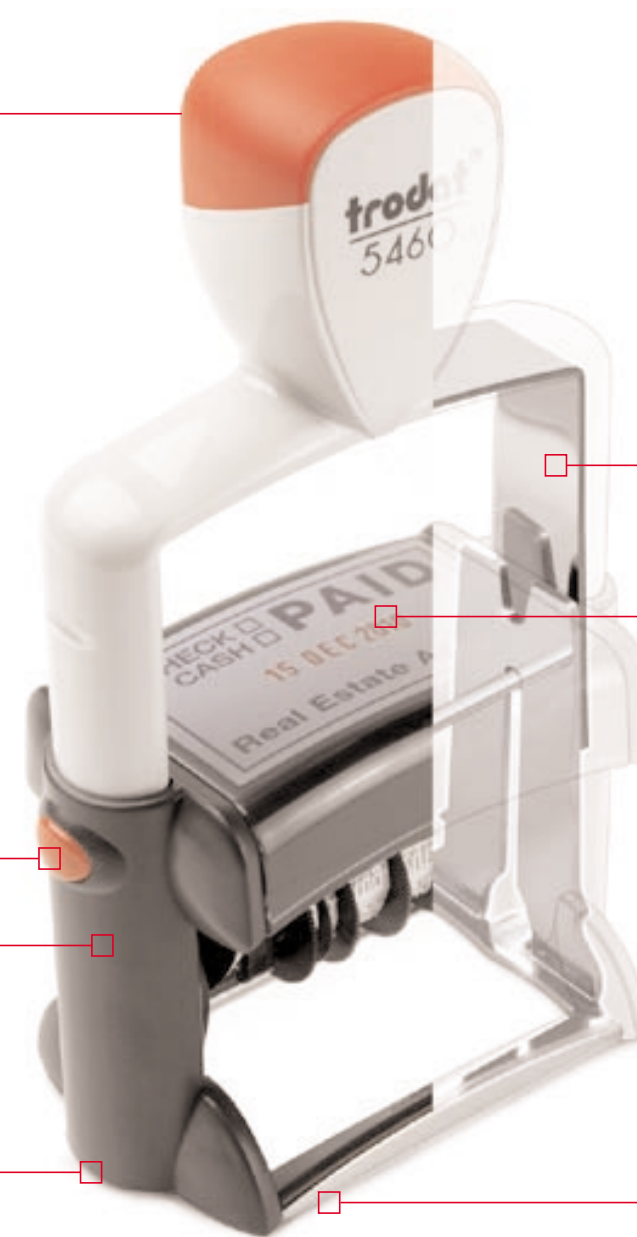



TEXT STAMPS_

For a company or address stamp, also available with company logo – a Professional Line stamp is available with a textplate size to suit every requirement.

SWOP-PAD REPLACEMENT PADS_ for all Professional Line models



5200



max. 41mm x 24mm



6/50

5203



max. 49mm x 28mm



6/53

5204

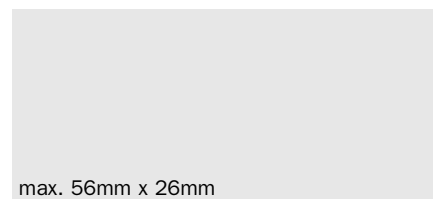

max. 56mm x 26mm
Also available in metallic



6/56

5205

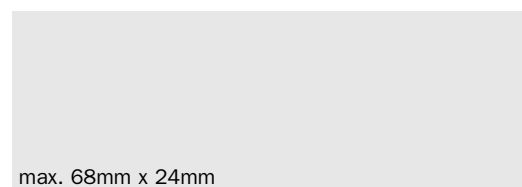

max. 68mm x 24mm



6/55

5206



max. 56mm x 33mm



6/56

5207



max. 60mm x 40mm



6/57

5208



max. 68mm x 47mm



6/58

5215

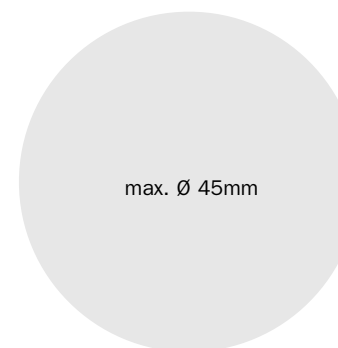

max. Ø 45mm



6/15



Daters with customised textplates in various textplate sizes.
Easy to set date using the turning wheels.

SWOP-PAD REPLACEMENT PADS – 2-COLOUR_

for: 5415, 5430, 5431, 5440, 5460, 5470, 5480, 5430/L, 5440/L, 5460/L



5430

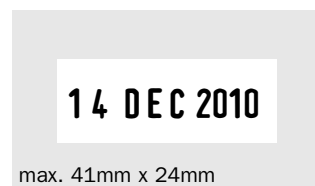

max. 41mm x 24mm
Date size: 4mm
Also available in metallic



6/50

5470



max. 60mm x 40mm
Date size: 4mm



6/57

5480

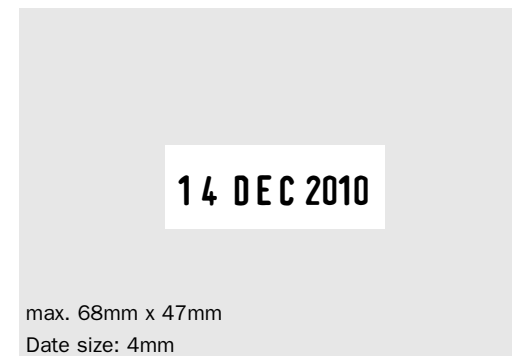

max. 68mm x 47mm
Date size: 4mm



6/58

5431

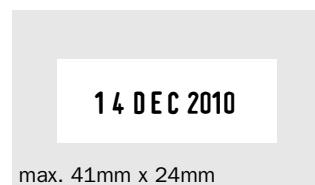

max. 41mm x 24mm
Date size: 3mm



6/50

5415

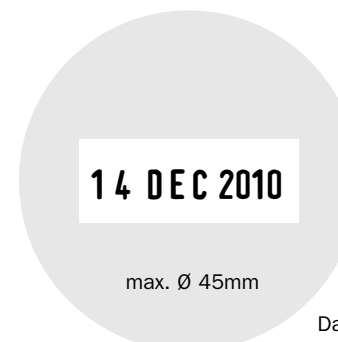

max. Ø 45mm

Date size: 4mm



6/15

5440



max. 49mm x 28mm
Date size: 4mm



6/53

5466/PL

Double dater



textplate thickness including adhesive film: 2.4mm

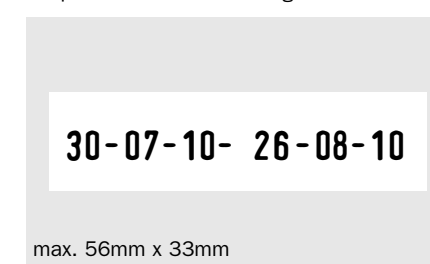

max. 56mm x 33mm

Date size: 4mm



6/56

5460



max. 56mm x 33mm
Date size: 4mm



6/56



Setting the date:



Adjusting the date bands to the exact height of the textplate:

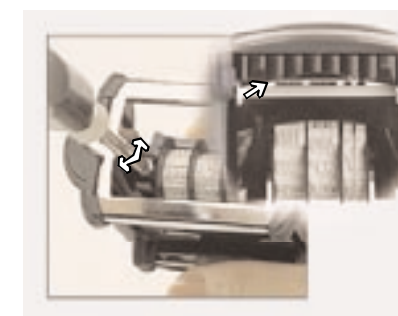



Setting text band

The office organisation professionals - daters, daters with stock texts, numberers and dial-a-phrase daters.

Easy to set date, numbers and text bands by using the turning wheels.

5030
5430/L



14 DEC 2010

Date size: 4mm

5430/L



PAID
14 DEC 2010
Per.....

Also available:
FAXED, RECEIVED



5430/L

6/50 (5030)

6/50/2 (5430/L)

5546



1 2 3 4 5 6

Character size: 4mm

Additional characters:

N° / / , ¼ Kg
€ - - F ½ %
· X C ¾ /
\$



6/50

5558



1 2 3 4 5 6 7 8

Character size: 5mm

Additional characters:
5558, 5558/PL:

N° / / / / , ¼ Kg
€ - - - F ½ %
· · · X C ¾ /
\$



6/56

5440/L



RECEIVED

14 DEC 2010

Date size: 4mm

Also available:
PAID
FAXED
POSTED



6/53/2

5558/PL



1 2 3 4 5 6 7 8

max. 56mm x 33mm

Character size: 5mm, textplate thickness
including adhesive film: 2.4mm



6/56

5460/L



L 1:

RECEIVED

14 DEC 2010

Date size: 4mm

Also available:
L2: PAID
L9: FAXED



6/56/2

55510



1 2 3 4 5 6 7 8 9 1

Character size: 5mm

Additional characters:
55510, 55510/PL:

N° / / , ¼ Kg / , Kg N°
€ - - F ½ % - F ½ % €
· X C ¾ / · C / #
\$



6/56

5117



CHECKED 14 DEC 2010

Character size: 4mm

Other texts:

- | | | |
|----------------|--------------|-------------|
| 1. ANSWERED | 5. RECEIVED | 9. ENTERED |
| 2. Backordered | 6. CHARGED | 10. PAID |
| 3. CANCELLED | 7. CHECKED | 11. SHIPPED |
| 4. BILLED | 9. DELIVERED | 12. FAXED |



6/56

55510/PL



1 2 3 4 5 6 7 8 9 1

max. 56mm x 33mm

Character size: 5mm, textplate thickness
including adhesive film: 2.4mm



6/56



TRODAT PRINTY LINE_

THE ORIGINAL

Not for nothing is the Original Trodat Printy the most widely purchased self-inking stamp with more than 150 million stamps sold worldwide: the perfect all-round stamp for use in a wide range of activities.

Reliable quality, simple handling and a modern design have distinguished the Original Trodat Printy for thirty years.



ERGONOMIC DESIGN_
Dynamic shape complies with ergonomic guidelines

SOFT-TOUCH GRIP CAP_
Pleasant handling, high quality, contemporary look (soft-touch material with Printy sizes 4910-4913)

DOUBLE-SIDED LOCKING MECHANISM_
2 locking positions make it easy to mount the textplate and change the pad.

STABILITY_
improved thanks to a widened, elliptical base and a new anti-slip feature.

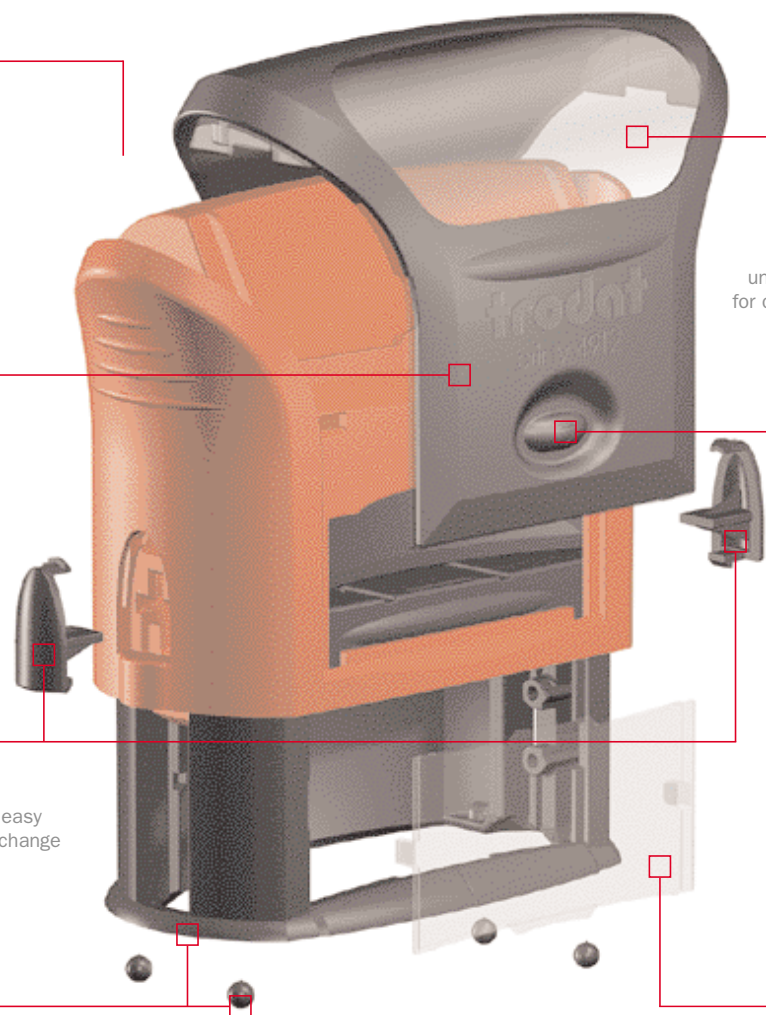

INDEX WINDOW_
Clearly positioned on the front of the stamp at a 45° angle for optimum view of impression

CLICK-OUT-BUTTON_
unique – and therefore patented – for clean and easy pad replacement at the touch of a button.
www.click-out.net

Eject pad using STOP-POSITION

POSITIONING WINDOW_
transparent, for accurate positioning of the stamp

TRODAT PRINTY RANGE_

For both name and address stamps with 2, 3 or more lines, Trodat now provides you with the New Printy, equipped with a textplate size to suit your requirements.

All models are supplied with a built-in stamp pad which can be easily replaced after many impressions.

COLOUR RANGE_

| STANDARD RANGE (Casing and grip cap: anthracite) | Frame colour |
|---|--------------|
| | red |
| | grey |
| | blue |
| | mint |
| | mango |
| | black |
| | yellow |

| | 4908 | 4910 | 4911 | 4912 | 4913 | 4915 | 4925 | 4926 | 4927 | 4928 | 4929 | 44055 | 46019 | 46025 | 46030 | 46040 |
|---|------|------|------|------|------|------|------|------|------|------|------|-------|-------|-------|-------|-------|
| 1 | X | X | X | X | X | X | X | X | X | X | X | X | X | X | X | X |
| 2 | X | X | X | X | X | X | X | X | X | X | X | X | X | X | X | X |
| 3 | X | X | X | X | X | X | X | X | X | X | X | X | X | X | X | X |
| 4 | X | X | X | X | X | | | | | | | | | | | |
| 5 | X | X | X | X | X | | | | | | | | | | | |
| 6 | X | | | | | | | | | | | | | | | |
| 7 | X | | | | | | | | | | | | | | | |

Daters 4729 – 46140: red/anthracite 1



PAD REPLACEMENT_

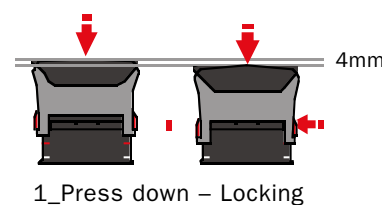

2_Push click-out button

www.click-out.net



SWOP-PAD REPLACEMENT PADS_ for all Printy Line models



SWOP-PAD REPLACEMENT PADS – 2-COLOUR_ for various daters





NEW PRINTY_ TEXT STAMPS

4908



with protective cap

max. 15mm x 7mm **1 6 7**



6/4908

4910



max. 26mm x 9mm **1-5**



6/4910

4911



max. 38mm x 14mm **1-5**



6/4911

4912



max. 47mm x 18mm **1-5**



6/4912

4913



max. 58mm x 22mm **1-5**



6/4913

4915



max. 70mm x 25mm **1-5**



6/4915

NEW PRINTY_ TEXT STAMPS

4929



max. 50mm x 30mm **1-3**



6/4929

4928



max. 60mm x 33mm **1-3**

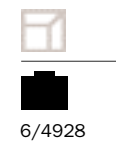

6/4928

4927



max. 60mm x 40mm **1-3**



6/4927

4926



max. 75mm x 38mm **1-3**



6/4926

4925



max. 82mm x 25mm **1-3**
Available from February 2006

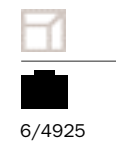

6/4925



NEW PRINTY_ TEXT STAMPS

46019

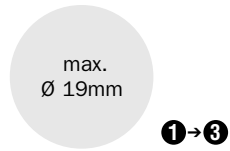

max. \varnothing 19mm
With protective cap
Available from April 2006



6/46019

46025



max. \varnothing 25mm
With protective cap
Available from April 2006



6/46025

46030



1 → 3



6/46030

46040

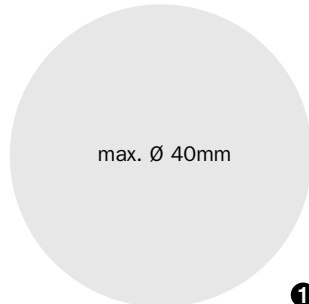

1 → 3



6/46040

44055

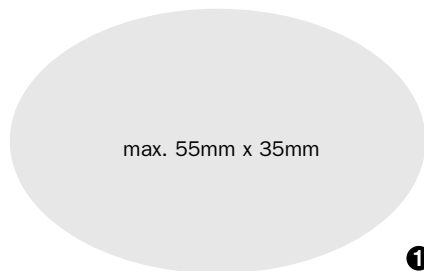

1 → 3



6/44055

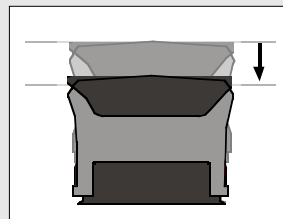

Affix the text plate

PRINTY CLASSIC_ TEXT STAMPS

Stamp equipment from the Printy Line series – individual in every case: As text, date or dial-a-phrase text stamp, with rectangular, square or circular text plate.

All Printy models are available in the standard black/grey casing (as shown below). Other colors are available on request.

4941
4917
4916



4941

max. 41mm x 24mm

4917

max. 50mm x 10mm

4916

max. 70mm x 10mm



6/4750 (4941)
6/4916 (4916)
6/4817 (4917)

4921
4922



4921

max. 12mm x 12mm



4922

max. 20mm x 20mm



6/4921
6/4922

4923
4924



4923

max. 30mm x 30mm

4924

max. 40mm x 40mm



6/4924
6/4923

46045

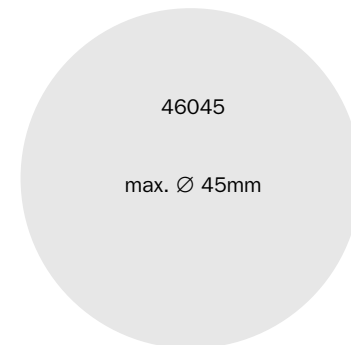

46045

max. \varnothing 45mm



6/46145



NEW PRINTY_ DATE + TEXT

SWOP-PAD REPLACEMENT PADS – 2-COLOUR_
for: 4729, 4727, 4726, 46130, 46140, 46145, 4750, 4850



4729

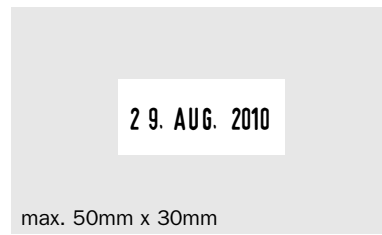

max. 50mm x 30mm

Date size: 3mm



6/4929

4727



max. 60mm x 40mm

Date size: 4mm



6/4927

4726



max. 75mm x 38mm

Date size: 4mm



6/4926

46140
46130

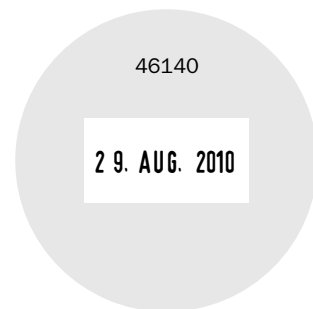

max. Ø 40mm
Date size: 3mm



max. Ø 30mm
Date size: 3mm



6/46030
6/46040

46125
46119



max. Ø 25mm
Date size: 2.8mm

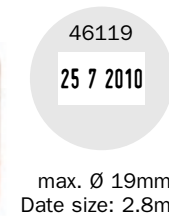

max. Ø 19mm
Date size: 2.8mm



6/46019
6/46025

PRINTY CLASSIC_ DATE + TEXT, DATERS, NUMBERERS AND DIAL-A-PHRASE STAMPS

46145

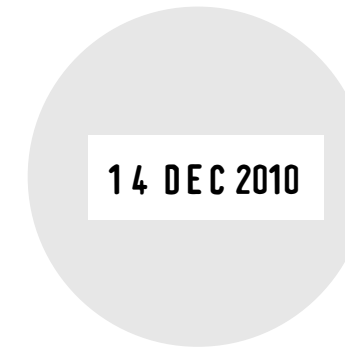

max. Ø 45mm
Date size: 4mm



6/46145

4724



max. 40mm x 40mm

Date size: 3mm



6/4924

4750



max. 41mm x 24mm
Date size: 4mm



6/4750

4750/L



L 1:



max. 41mm x 24mm
Date size: 4mm

L 2:



Also available: L 9: FAXED



6/4750/2

4800
4820



4800
Date size: 3mm

14 DEC 2010

4820
Date size: 4mm

14 DEC 2010

4810 Mini-Dater

Date size: 3.8mm

28 AUG 2010



6/4911 (4800)
6/4910 (4810)
6/4911 (4820)

4813



max. 26mm x 9mm

17. NOV 2010

Date size: 3.8mm



6/4817

4817



RECEIVED 17. NOV 2010

Character size: 3.8mm

Other texts for 4817:

| | | |
|-------------|-----------|---------|
| ANSWERED | RECEIVED | ENTERED |
| Backordered | CHARGED | PAID |
| CANCELLED | CHECKED | SHIPPED |
| BILLED | DELIVERED | FAXED |



6/4817

4822



ORIGINAL

Character size: 4mm

Other texts:

| | |
|-----------|--------------|
| CANCELLED | ORIGINAL |
| FAXED | COPY |
| DRAFT | AIR MAIL |
| APPROVED | FIRST CLASS |
| URGENT! | CONFIDENTIAL |
| PLEASE! | CONFIRMATION |



6/4911

4836

4846

48313



4836

Character size: 3.8mm 1 2 3 4 5 6

Additional characters (4846):

Nº / / , 1/4 Kg
 € - - F 1/2 %
 # · X C 1/4 /
 \$

4846

Character size: 4mm 1 2 3 4 5 6

48313

Character size: 3.8mm 1 2 3 4 5 6 7 8 9 0 1 2 3



6/4910 (4836)
 6/4911 (4848)
 6/4917 (48313)

4850

4850/L



max. 25mm x 5mm

2 8 AUG 2010

4850 -
 Date size: 3.8mm,
 Textplate thickness: 2.3mm

L 1: RECEIVED

2 8 AUG 2010

4850/L -
 Date size: 3.8mm

Also available:

L 2: PAID
 L 9: FAXED



4850/L
 6/4850 (4850)
 6/4850/2 (4850L)



Setting the date:



Adjusting the date bands to the exact height of the textplate:

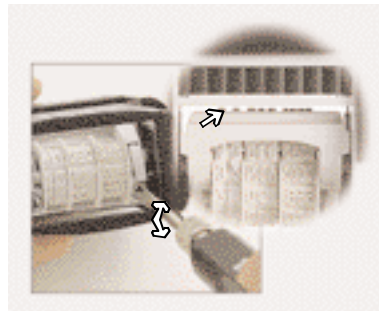

TRODAT TYPOMATIC LINE_

DO IT YOURSELF!

The models in our Typomatic line have all the advantages of the Printy and Professional lines, as well as the option of individually setting and changing the stamp text as required.

Typomatic Line stamps are available as phrase stamps and daters in several different textplate sizes.

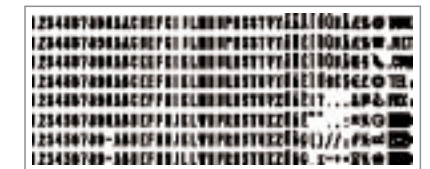

6003 NEW - 336 characters

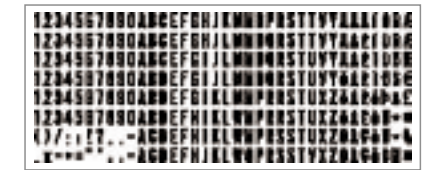

6004 NEW - 288 characters

Accessories: depending on model 1 or 2 letter sets, 1 pair of tweezers, 1 Swop-Pad replacement pad

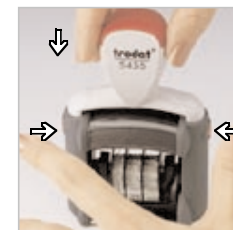

Letter sets: Specially developed sets to include a selection of letters, numbers and special characters. They can be used with all Typomatic models in the Printy and Professional lines.



TYPOMATIC LINE – PRINTY_ DO-IT-YOURSELF TEXT + DATE STAMPS

New or amended post codes, telephone numbers or addresses...
Do-it-yourself Printys are the benchmark of today's requirement for flexibility.

4911_
typo



ROBERT NORMAN
EXPORT MANAGER
VIENNA-AUSTRIA

For up to 3 lines of text, 1 letter set 6003
(character size 3mm)



6/4911

4755



LICENCE EXP.
★ 14 DEC 2010 ★
C.M.O. N F 82/88

Date size: 4mm
For up to 2 lines of text
1 letter set 6004 (character size 4mm)



6/4750/2

4912_
typo



ROBERT NORMAN
EXPORT MANAGER
A-4000 WELS AUSTRIA
07242/239-0

For up to 4 lines of text, 1 letter set 6003
(character size 3mm), 1 letter set 6004
(character size 4mm)

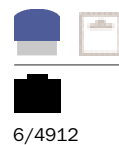

6/4912

4727_
typo



ROBERT NORMAN
EXPORT MANAGER
LINZEN STRASSE 15B
14 DEC 2010
+43 0 7242/239-0
ROBERT.NORMAN@TRODAT.NET
WWW.TRODAT.NET

Date size: 4mm; for up to 6 lines of text, 1 letter
set 6003 (character size 3mm), 1 letter set 6004
(character size 4mm)



6/4927/2

4913_
typo



ROBERT NORMAN
EXPORT MANAGER
LINZEN STRASSE 15B
A-4000 WELS AUSTRIA
07242/239-0

For up to 5 lines of text, 1 letter set 6003
(character size 3mm), 1 letter set 6004
(character size 4mm)



6/4913

46030_
typo



1 letter set 6003
(character size 3mm)

R 1



6/46030

4928_
typo



ROBERT NORMAN
EXPORT MANAGER
LINZEN STRASSE 15B
A-4000 WELS AUSTRIA
+43 0 7242/239-0
ROBERT.NORMAN@TRODAT.NET
WWW.TRODAT.NET

For up to 7 lines of text, 1 letter set 6003
(character size 3mm), 1 letter set 6004
(character size 4mm)

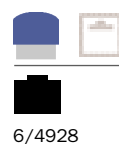

6/4928

46040_
typo



1 letter set 6003
(character size 3mm)

R 1

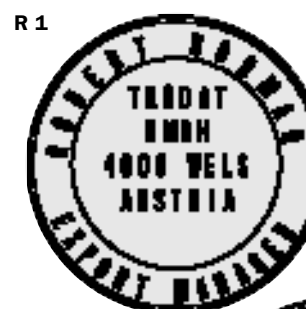

R 1,5



R 2

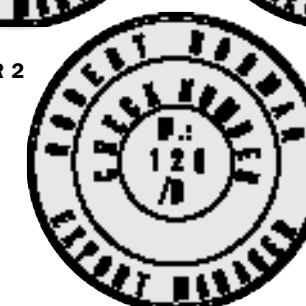

6/46040

4927_
typo



TRODAT GMBH
ROBERT NORMAN
EXPORT MANAGER
LINZER STRASSE 15B
A-4000 WELS AUSTRIA
+43 0 7242/239-0
ROBERT.NORMAN@TRODAT.NET
WWW.TRODAT.NET

For up to 8 lines of text, 1 letter set 6003
(character size 3mm), 1 letter set 6004
(character size 4mm)

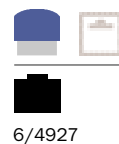

6/4927



TYPOMATIC LINE – PROFESSIONAL_

DO-IT-YOURSELF TEXT + DATE STAMPS

Do-it-yourself stamps from the Professional Line – in addition to the advantages of this product, the 5253 model offers an additional special feature: two dieplates which provide two easily interchangeable stamp texts.

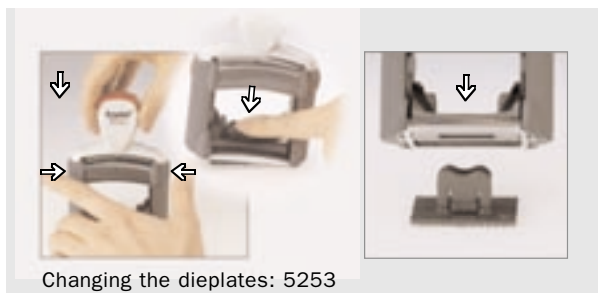

Changing the dieplates: 5253

5253



ROBERT NORMAN
EXPORT MANAGER
LINZEN STRASSE 160
A-4000 WELS AUSTRIA
0 7 2 4 2 - 2 2 9 - 0
0 7 2 4 2 - 2 3 9 - 0 2 0

For up to 6 lines of text,
1 letter set 6003 (character size 3mm)
1 letter set 6004 (character size 4mm)



6/53

5435



LICENCE EXP.
★ 14 DEC 2010 ★
C.M.D. N° F B2/88

Date size: 4mm

For up to 2 lines of text,
1 letter set 6004 (character size 4mm)



6/50/2

5465



SPECIAL OFFER FROM
YOUR STATION
14 DEC 2010
FOR
1 FREE CAN WASH

Date size: 4mm

For up to 4 lines of text
1 letter set 6003 (character size 3mm)
1 letter set 6004 (character size 4mm)



6/56/2



TRODAT SWOP-PAD REPLACEMENT PADS_

SWOP-Pad, the original Trodat replacement pad for the Printy and Professional Lines, guarantees consistently outstanding quality – from the first impression to the last.



no re-inking



clean hands



clean impression



5 stock colours



ORIGINAL BY TRODAT

THE ADVANTAGES SPEAK FOR THEMSELVES_

- clean impression, document quality
- precise inking prevents colours running
- no drying out; non-toxic colourings; free of heavy metals
- clean pad change in no time at all



STAMP QUALITY_
2-part pad material and precise metering of ink ensures that the pad does not dry out and thus guarantees consistently outstanding quality

TWO IN ONE_
for daters and other special applications, such as seal stamps, a 2-colour red and blue SWOP-Pad is available.

PAD REPLACEMENT_

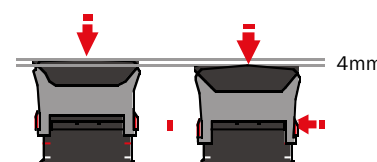

1_Press down – Locking

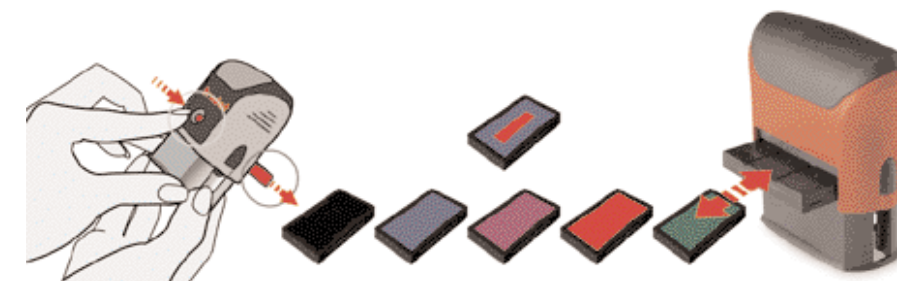

2_Push click-out button
www.click-out.net

3_Insert new replacement pad

PROFESSIONAL LINE_



| Stamp | SWOP-PAD | | black | blue | red | violet | green | blue/red | SWOP-PADS FOR SPECIAL APPLICATIONS |
|----------|----------|--------|-------|------|-----|--------|-------|-------------------|--|
| | NEW | OLD | | | | | | | |
| 5200 | 6/50 | 6/4430 | ■ | ■ | ■ | ■ | ■ | - | - |
| 5203 | 6/53 | 6/4610 | ■ | ■ | ■ | ■ | ■ | - | - |
| 5204 | 6/56 | 6/4420 | ■ | ■ | ■ | ■ | ■ | - | - |
| 5205 | 6/55 | - | ■ | ■ | ■ | ■ | ■ | - | - |
| 5206 | 6/56 | 6/4420 | ■ | ■ | ■ | ■ | ■ | - | - |
| 5207 | 6/57 | - | ■ | ■ | ■ | ■ | ■ | - | - |
| 5208 | 6/58 | 6/4208 | ■ | ■ | ■ | ■ | ■ | - | - |
| 5215 | 6/15 | - | ■ | ■ | ■ | ■ | ■ | - | 6/15/2R red outside/blue inside (Ø 30mm) |
| 5030 | 6/50 | 6/4430 | ■ | ■ | ■ | ■ | ■ | - | - |
| 5415 | 6/15 | - | ■ | ■ | ■ | ■ | ■ | 6/15/2 | - |
| 5430 | 6/50 | 6/4430 | ■ | ■ | ■ | ■ | ■ | 6/50/2 | - |
| 5430/L | 6/50 | 6/4430 | ■ | ■ | ■ | ■ | ■ | 6/50/2 | - |
| 5431 | 6/50 | 6/4430 | ■ | ■ | ■ | ■ | ■ | 6/50/2 | - |
| 5440 | 6/53 | 6/4610 | ■ | ■ | ■ | ■ | ■ | 6/53/2 | - |
| 5440/L | 6/53 | 6/4610 | ■ | ■ | ■ | ■ | ■ | 6/53/2 | - |
| 5460 | 6/56 | 6/4420 | ■ | ■ | ■ | ■ | ■ | 6/56/2 | - |
| 5460/L | 6/56 | 6/4420 | ■ | ■ | ■ | ■ | ■ | 6/56/2 | - |
| 5470 | 6/57 | - | ■ | ■ | ■ | ■ | ■ | 6/57/2 | - |
| 5480 | 6/58 | 6/4208 | ■ | ■ | ■ | ■ | ■ | 6/58/2 | - |
| 5117 | 6/56 | 6/4420 | ■ | ■ | ■ | ■ | ■ | - | - |
| 5546 | 6/50 | 6/4430 | ■ | ■ | ■ | ■ | ■ | - | - |
| 5558 | 6/56 | 6/4420 | ■ | ■ | ■ | ■ | ■ | - | - |
| 5558/PL | 6/56 | 6/4420 | ■ | ■ | ■ | ■ | ■ | 6/56/2 | - |
| 55510 | 6/56 | 6/4420 | ■ | ■ | ■ | ■ | ■ | - | - |
| 55510/PL | 6/56 | 6/4420 | ■ | ■ | ■ | ■ | ■ | 6/56/2 | - |
| 5253 | 6/53 | 6/4610 | ■ | ■ | ■ | ■ | ■ | - | - |
| 5435 | 6/50 | 6/4430 | ■ | ■ | ■ | ■ | ■ | 6/50/2 | - |
| 5465 | 6/56 | 6/4420 | ■ | ■ | ■ | ■ | ■ | 6/56/2 | - |
| 5466 | 6/56 | 6/4420 | ■ | ■ | ■ | ■ | ■ | - | - |

~~6/56/2~~ = not suitable for the corresponding stamp

METAL SELF-INKING STAMPS (OLD MODELS)_



| Stamp | NEW | OLD | black | blue | red | violet | green | blue/red | SWOP-PADS FOR SPECIAL APPLICATIONS |
|------------|------|--------|-------|------|-----|--------|-------|---------------------|------------------------------------|
| 4200 | 6/50 | 6/4430 | ■ | ■ | ■ | ■ | ■ | - | - |
| 4202 | - | 6/4202 | ■ | ■ | ■ | ■ | ■ | - | - |
| 4203 | 6/53 | 6/4610 | ■ | ■ | ■ | ■ | ■ | - | - |
| 4204 | - | 6/4204 | ■ | ■ | ■ | ■ | ■ | - | - |
| 4206 | 6/56 | 6/4420 | ■ | ■ | ■ | ■ | ■ | - | - |
| 4207 | - | 6/4207 | ■ | ■ | ■ | ■ | ■ | - | - |
| 4208 | 6/58 | 6/4208 | ■ | ■ | ■ | ■ | ■ | - | - |
| 4000, 4010 | - | 6/4010 | ■ | ■ | ■ | ■ | ■ | - | - |
| 4400, 4410 | - | 6/4010 | ■ | ■ | ■ | ■ | ■ | - | - |
| 4420 | 6/56 | 6/4420 | ■ | ■ | ■ | ■ | ■ | 6/4420/2 | - |
| 4430 | 6/50 | 6/4430 | ■ | ■ | ■ | ■ | ■ | 6/4430/2 | - |
| 4430/L | 6/50 | 6/4430 | ■ | ■ | ■ | ■ | ■ | 6/4430/2 | - |
| 4431 | 6/50 | 6/4430 | ■ | ■ | ■ | ■ | ■ | 6/4430/2 | - |
| 4440 | 6/53 | 6/4610 | ■ | ■ | ■ | ■ | ■ | 6/4610/2 | - |
| 4460 | 6/56 | 6/4420 | ■ | ■ | ■ | ■ | ■ | 6/4420/2 | - |
| 4470 | - | 6/4207 | ■ | ■ | ■ | ■ | ■ | 6/4207/2 | - |
| 4480 | 6/58 | 6/4208 | ■ | ■ | ■ | ■ | ■ | 6/4208/2 | - |
| 4022 | 6/50 | 6/4430 | ■ | ■ | ■ | ■ | ■ | - | - |
| 4030 | 6/50 | 6/4430 | ■ | ■ | ■ | ■ | ■ | - | - |
| 4031 | 6/50 | 6/4430 | ■ | ■ | ■ | ■ | ■ | - | - |
| 4034 | 6/50 | 6/4430 | ■ | ■ | ■ | ■ | ■ | - | - |
| 4117 | - | 6/4204 | ■ | ■ | ■ | ■ | ■ | - | - |
| 4546 | 6/50 | 6/4430 | ■ | ■ | ■ | ■ | ■ | - | - |
| 4548 | 6/50 | 6/4430 | ■ | ■ | ■ | ■ | ■ | - | - |
| 4558 | 6/53 | 6/4610 | ■ | ■ | ■ | ■ | ■ | - | - |
| 4558/PL | 6/53 | 6/4610 | ■ | ■ | ■ | ■ | ■ | 6/4610/2 | - |
| 45510 | - | 6/4204 | ■ | ■ | ■ | ■ | ■ | - | - |
| 45510/PL | - | 6/4204 | ■ | ■ | ■ | ■ | ■ | - | - |
| 4610 | 6/53 | 6/4610 | ■ | ■ | ■ | ■ | ■ | 6/4610/2 | - |

PRINTY LINE_



| Stamp | SWOP-PAD | | black | blue | red | violet | green | blue/red | SWOP-PADS FOR SPECIAL APPLICATIONS |
|---------------|----------|-----|-------|------|-----|--------|-------|-----------|---|
| | NEW | OLD | | | | | | | |
| 4908 | 6/4908 | - | ■ | ■ | ■ | ■ | ■ | - | - |
| 4910 | 6/4910 | - | ■ | ■ | ■ | ■ | ■ | - | - |
| 4911 (typo) | 6/4911 | - | ■ | ■ | ■ | ■ | ■ | - | 6/4911 (C) with textile ink for Clothing Marker |
| 4912 (typo) | 6/4912 | - | ■ | ■ | ■ | ■ | ■ | - | 6/4912 neon-orange and neon-pink |
| 4913 (typo) | 6/4913 | - | ■ | ■ | ■ | ■ | ■ | - | - |
| 4915 | 6/4915 | - | ■ | ■ | ■ | ■ | ■ | - | - |
| 4916 | 6/4916 | - | ■ | ■ | ■ | ■ | ■ | - | - |
| 4917 | 6/4817 | - | ■ | ■ | ■ | ■ | ■ | - | - |
| 4921 / 492150 | 6/4921 | - | ■ | ■ | ■ | ■ | ■ | - | - |
| 4922 | 6/4922 | - | ■ | ■ | ■ | ■ | ■ | - | - |
| 4923 / 4930 | 6/4923 | - | ■ | ■ | ■ | ■ | ■ | - | 6/4923/2 blue outside/red inside (Ø 15mm) |
| 4924 / 4940 | 6/4924 | - | ■ | ■ | ■ | ■ | ■ | - | - |
| 4925 | 6/4925 | - | ■ | ■ | ■ | ■ | ■ | - | - |
| 4926 | 6/4926 | - | ■ | ■ | ■ | ■ | ■ | - | - |
| 4927 (typo) | 6/4927 | - | ■ | ■ | ■ | ■ | ■ | - | - |
| 4928 (typo) | 6/4928 | - | ■ | ■ | ■ | ■ | ■ | - | - |
| 4929 | 6/4929 | - | ■ | ■ | ■ | ■ | ■ | - | - |
| 4941 (4760) | 6/4750 | - | ■ | ■ | ■ | ■ | ■ | - | - |
| 44055 | 6/44055 | - | ■ | ■ | ■ | ■ | ■ | - | - |
| 46019 | 6/46019 | - | ■ | ■ | ■ | ■ | ■ | - | - |
| 46025 | 6/46025 | - | ■ | ■ | ■ | ■ | ■ | - | - |
| 46030 (typo) | 6/46030 | - | ■ | ■ | ■ | ■ | ■ | - | - |
| 46040 (typo) | 6/46040 | - | ■ | ■ | ■ | ■ | ■ | - | 6/46040/2R blue outside/red inside (Ø 22mm) |
| 46045 | 6/46145 | - | ■ | ■ | ■ | ■ | ■ | - | - |
| 4724 | 6/4924 | - | ■ | ■ | ■ | ■ | ■ | - | - |
| 4726 | 6/4926 | - | ■ | ■ | ■ | ■ | ■ | 6/4926/2 | - |
| 4727 (typo) | 6/4927 | - | ■ | ■ | ■ | ■ | ■ | 6/4927/2 | - |
| 4729 | 6/4929 | - | ■ | ■ | ■ | ■ | ■ | 6/4929/2 | - |
| 4740 | 6/4924 | - | ■ | ■ | ■ | ■ | ■ | - | - |
| 4750 / 4750L | 6/4750 | - | ■ | ■ | ■ | ■ | ■ | 6/4750/2 | - |
| 46119 | 6/46019 | - | ■ | ■ | ■ | ■ | ■ | - | - |
| 46125 | 6/46025 | - | ■ | ■ | ■ | ■ | ■ | - | - |
| 46130 | 6/46030 | - | ■ | ■ | ■ | ■ | ■ | 6/46030/2 | - |
| 46140 | 6/46040 | - | ■ | ■ | ■ | ■ | ■ | 6/46040/2 | - |
| 46145 | 6/46145 | - | ■ | ■ | ■ | ■ | ■ | 6/46145/2 | - |
| 4800 | 6/4911 | - | ■ | ■ | ■ | ■ | ■ | - | - |
| 4810 | 6/4910 | - | ■ | ■ | ■ | ■ | ■ | - | - |
| 4813 | 6/4817 | - | ■ | ■ | ■ | ■ | ■ | - | - |
| 4817 / 4812 | 6/4817 | - | ■ | ■ | ■ | ■ | ■ | - | - |
| 4820 | 6/4911 | - | ■ | ■ | ■ | ■ | ■ | - | - |
| 4822 | 6/4911 | - | ■ | ■ | ■ | ■ | ■ | - | - |
| 4836 | 6/4910 | - | ■ | ■ | ■ | ■ | ■ | - | - |
| 48313 | 6/4817 | - | ■ | ■ | ■ | ■ | ■ | - | - |
| 4846 | 6/4911 | - | ■ | ■ | ■ | ■ | ■ | - | - |
| 4850 / 4850L | 6/4850 | - | ■ | ■ | ■ | ■ | ■ | 6/4850/2 | - |
| 4951 | 6/4911 | - | ■ | ■ | ■ | ■ | ■ | - | - |
| 4952 | 6/4912 | - | ■ | ■ | ■ | ■ | ■ | - | - |
| 4953 | 6/4913 | - | ■ | ■ | ■ | ■ | ■ | - | - |
| 4957 | 6/4927 | - | ■ | ■ | ■ | ■ | ■ | - | - |
| 4958 | 6/4928 | - | ■ | ■ | ■ | ■ | ■ | - | - |
| 4755 | 6/4750 | - | ■ | ■ | ■ | ■ | ■ | 6/4750/2 | - |
| 4757 | 6/4927 | - | ■ | ■ | ■ | ■ | ■ | 6/4927/2 | - |
| 496201 - 04 | 6/4912 | - | ■ | ■ | ■ | ■ | ■ | - | - |

PRINTY (OLD MODELS)_



| Stamp | NEW | OLD | black | blue | red | violet | green | blue/red | SWOP-PADS FOR SPECIAL APPLICATIONS |
|-----------|------------|-----|-------|------|-----|--------|-------|----------|------------------------------------|
| 4700 | 6/4710 | - | ■ | ■ | ■ | ■ | ■ | - | - |
| 4710 | 6/4710 | - | ■ | ■ | ■ | ■ | ■ | - | - |
| 4722 | 6/4710 | - | ■ | ■ | ■ | ■ | ■ | - | - |
| 4746 | 6/4710 | - | ■ | ■ | ■ | ■ | ■ | - | - |
| 4914 | 6/4914 | - | ■ | ■ | ■ | ■ | ■ | - | - |
| 4954 | 6/4914 | - | ■ | ■ | ■ | ■ | ■ | - | - |
| 4910 old* | 6/4910 old | - | ■ | ■ | ■ | ■ | ■ | - | - |

* SWOP-PADS are also suitable for all other old Printy models.



TRODAT IMPRESSOR PRE-INKED

All the features for a perfect impression. The Impressor by Trodat combines both intelligent technology and functional design. Experience a new standard in pre-inked stamps; we are sure you will be impressed.

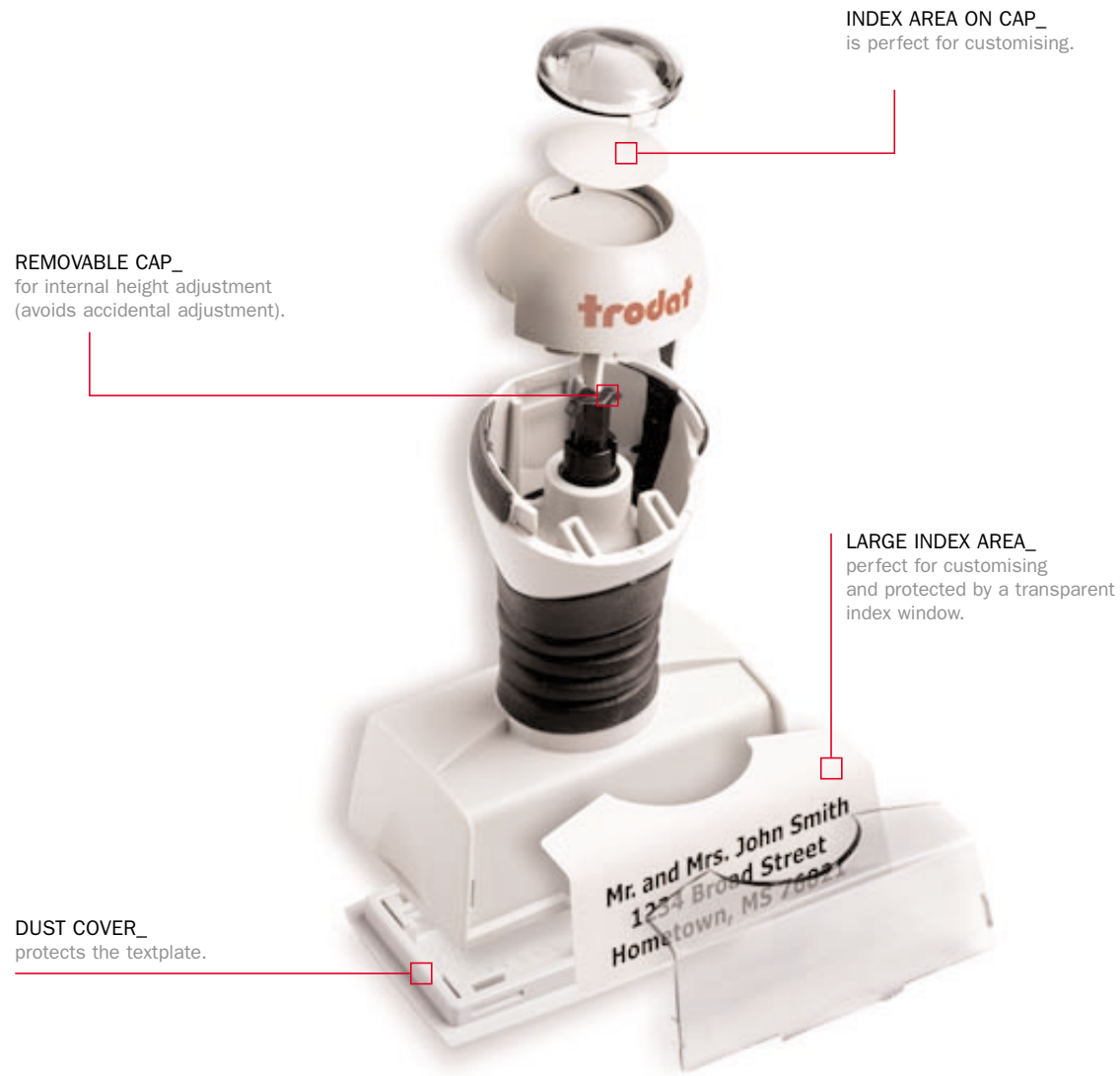

EASY TO USE_
the separate textplate holder allows for easy adjustment of the pre-inked textplate. The unique "click-in" function allows for easy adjustment and even pressure on the textplate.



ACCESSORIES RANGE_

- P800** - A4 Laser sheets for pre-inked textplates (ideal for use with a Laser appliance from Trotec)
- 7091** - Pre-inked stamp re-inking ink, 10ml (black, blue, red, green, violet)

RE-INKING_

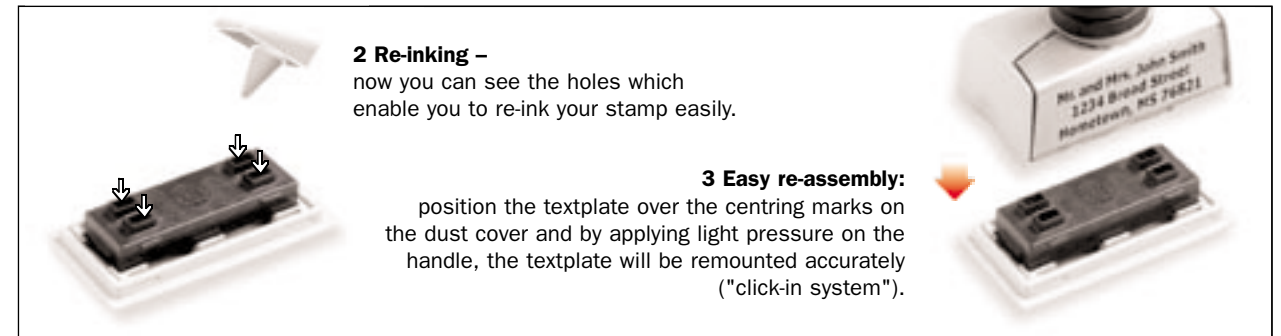
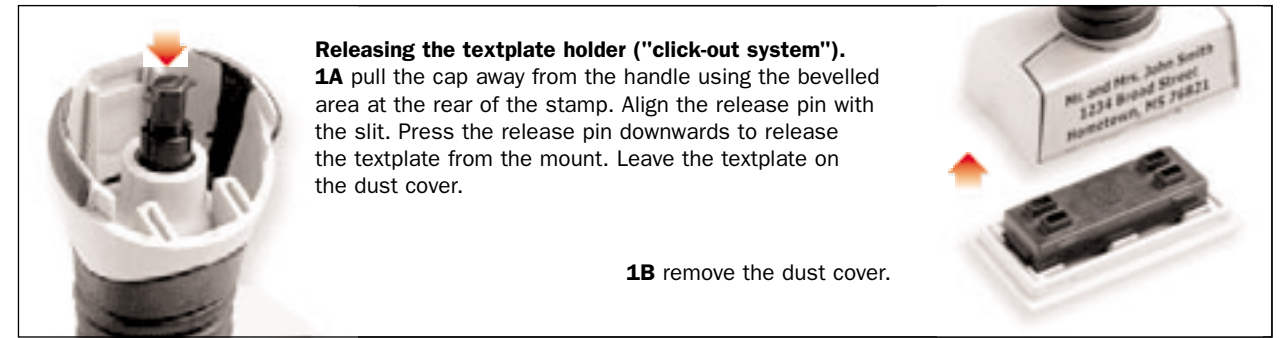

*For detailed instructions on re-inking, please refer to: www.trodat.net/reinking

TEXTPLATE SIZES_

22 Sizes

* for these sizes, the text plate can be produced using the Flash technology

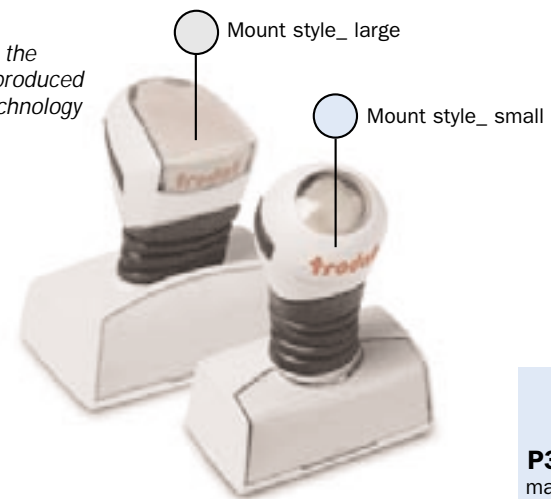

P301
max. 39mm x 12mm

P305
max. 65mm x 12mm

P307 *
max. 43mm x 18mm

P312
max. 25mm x 25mm

P309 *
max. 59mm x 18mm

P311 *
max. 75mm x 18mm

P340
max. Ø 15mm

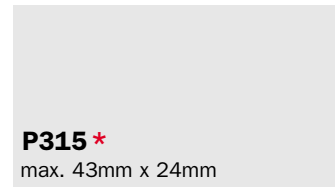

P315 *
max. 43mm x 24mm



P316 *
max. 56mm x 24mm

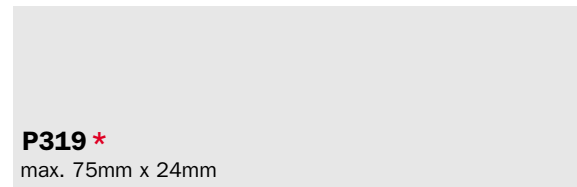

P319 *
max. 75mm x 24mm



P325 *
max. 94mm x 34mm

P323 *
max. 62mm x 34mm

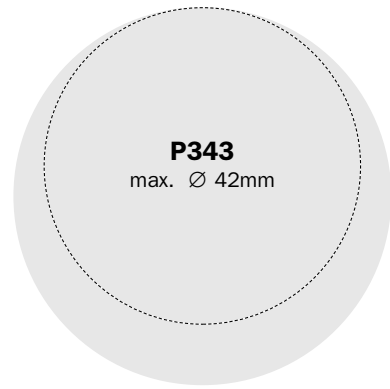

P343
max. Ø 42mm

P350
max. Ø 50mm

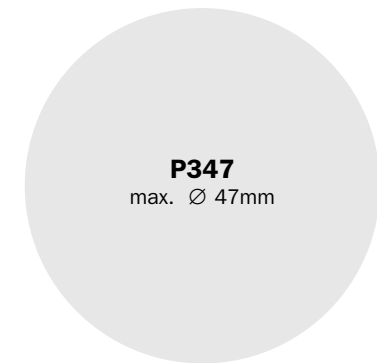

P347
max. Ø 47mm



P329 *
max. 81mm x 44mm

P327
max. 44mm x 44mm

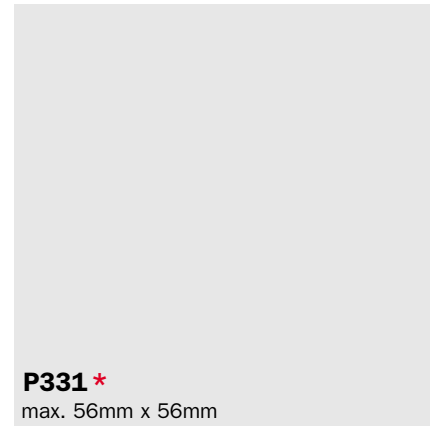

P331 *
max. 56mm x 56mm



P346
max. 49mm x 34mm

P348
max. 55mm x 39mm



P336 *
max. 104mm x 74mm

P333 *
max. 94mm x 56mm

Together with IMPRESSOR stamps, Trodat also offers a complete Flash System. This system consists of the following accessories to create a pre-inked Flash Stamp:

- **Flash text plate** (Flash die) - punched foam with sealed edges
- **Flash cartridge** (Flash ink reservoir) - pre-inked or uninked
- **Retainer ring** for mounting the flash text plate and ink cartridge
- Optional: **Flash ink 7093** 28ml or **7092/1** 1l - specially mixed for the Trodat System for inking the un-inked ink cartridge
- 8810 Vellum paper
- 8812 Protective film

THE FLASH-SYSTEM IS AVAILABLE FOR UP TO 12 SIZES:

IMPRESSOR FLASH KIT_

| PRODUCT NAME | Usable impression area in mm | CONSISTS OF: | | |
|----------------|------------------------------|------------------------------|--|---------------|
| | | Flash Text Plate (Flash Die) | Flash Cartridge (Flash Ink Reservoir)* | Retainer Ring |
| P307 FLASH KIT | 34 x 9 | 10 pcs | 10 pcs | 10 pcs |
| P309 FLASH KIT | 50 x 9 | 10 pcs | 10 pcs | 10 pcs |
| P311 FLASH KIT | 65 x 8 | 10 pcs | 10 pcs | 10 pcs |
| P315 FLASH KIT | 34 x 15 | 10 pcs | 10 pcs | 10 pcs |
| P316 FLASH KIT | 47 x 15 | 10 pcs | 10 pcs | 10 pcs |
| P319 FLASH KIT | 65 x 15 | 10 pcs | 10 pcs | 10 pcs |
| P323 FLASH KIT | 53 x 25 | 10 pcs | 10 pcs | 10 pcs |
| P325 FLASH KIT | 84 x 24 | 10 pcs | 10 pcs | 10 pcs |
| P329 FLASH KIT | 72 x 34 | 10 pcs | 10 pcs | 10 pcs |
| P331 FLASH KIT | 47 x 47 | 5 pcs | 5 pcs | 5 pcs |
| P333 FLASH KIT | 83 x 45 | 5 pcs | 5 pcs | 5 pcs |
| P336 FLASH KIT | 93 x 63 | 5 pcs | 5 pcs | 5 pcs |

*Flash Cartridge (ink cartridge, individually packed in plastic bag) inked in **black, blue** or **red** or un-inked (not individually packed).

Flash text plate, cartridge and retainer ring are also available individually (product no. + product description, for example, P307 Flash text plate or P307 Flash cartridge blue, etc).

THIS IS HOW THE NEW TRODAT FLASH SYSTEM WORKS_

1. **Affix text plate** and **print** onto vellum paper (using a laser printer).
2. **Flash process** (people who are already working with Flash will be familiar with this process).



Place the printed vellum paper (right-reading) onto the glass surface of the flash machine.



Place the protective film over the vellum paper.



Place the flash text plate on top of the protective film (printing side facing downwards). Adjust the text plate with the help of the printed alignment frame. To ensure the printing is even when flashing, place a 2mm thick plastic or metal plate on top of the text plate.



Close the flash machine and activate the flash (with most devices, the flash is automatically activated after the lid has been closed).



THIS IS HOW THE NEW TRODAT FLASH SYSTEM WORKS_

3. Mounting the stamp



Place the finished text plate into the retainer ring with the printed side facing downwards.



Place the saturated ink cartridge on top of the text plate.



Insert the set (text plate, ink cartridge and retainer ring) into the text plate holder.



Place the entire text plate assembly onto the centering marks of the dust cover. Now place the stamp on top of it and press down gently on the handle to ensure that the text plate assembly is correctly mounted in the stamp.



FINISHED!
(The stamp is ready for use after 1-2 hours)

Mounting of larger sizes (P323, P325, P329, P331, P333, P336)



Only for P333 and P336:
Place a drop of glue in the middle of the flashed text plate.

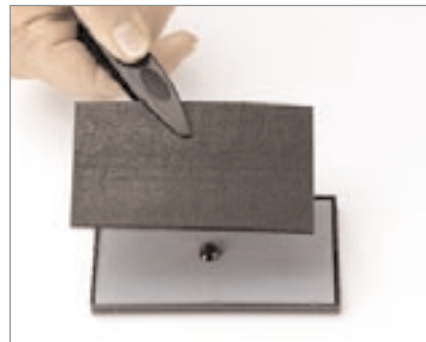

P323, P325, P329, P331, P333, P336. Place the saturated ink cartridge on top of the text plate. Place four drops of glue into the text plate holder (6 drops of glue for size P336).

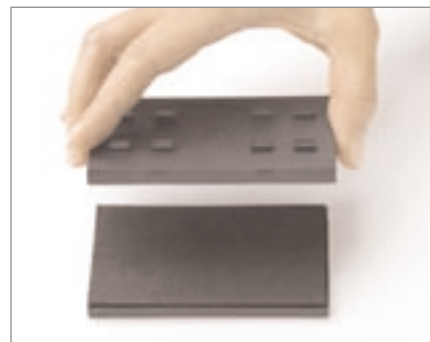

Insert the set (text plate, ink cartridge and retainer ring) into the text plate holder as shown above. Press together and hold for several seconds. The retainer ring must be fully inserted in the text plate holder.



Place the entire text plate assembly onto the centering marks of the dust cover. Now place the stamp on top of it and press down gently on the handle to ensure that the text plate assembly is correctly mounted in the stamp.



FINISHED!
(The stamp is ready for use after 1-2 hours)



TRODAT CLASSIC LINE_

Products from the Classic Line Series are stamps that can truly be described as evergreen.

Hand stamps from the Classic Line series are available as date stamps (with or without text), dial-a-phrase stamps or numberers.

The Classic Line offers a range of distinct product advantages. The 2910 model is remarkable as much for its modern design as for its compound structure which contains a super strong metal core.



FUNCTIONAL_
the turning wheels are used to set the date and to identify the front of the stamp.

PRACTICAL_
the locking mechanism allows you to open the dieplate easily.

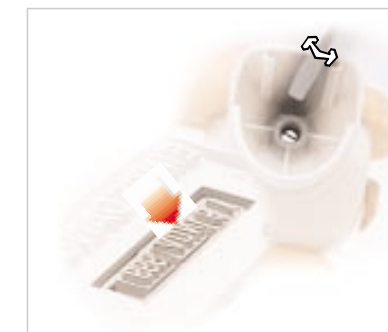

SIMPLE_
band height adjustment using a screw inside the handle.

PRACTICAL_
setting the date:
made easy.





DATE + TEXT_

The 2910 Dater series, with many different dieplate sizes, makes this range suitable for any text. Special plates and standard texts are available upon request.

2910



Date size:
4 mm

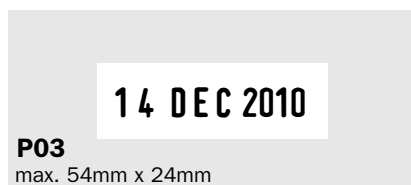
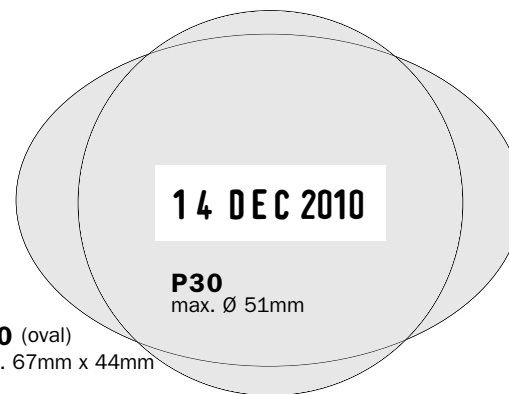

ADJUSTING THE DATE BANDS TO THE EXACT HEIGHT OF THE TEXTPLATE.



TIME + DATE STAMPS_

The 2910 model is also available as a time and date stamp with a choice of 12-hour or 24-hour format.

2910/U1-12 2910/U1-24



2910/U1-12
Ø 50mm, Date size: 4mm



2910/U1-24
Ø 50mm, Date size: 4mm



The time is set by simply turning the dial unit.



All Square – the range of durable metal-bodied daters with many different dieplate sizes which makes this range suitable for any text.

**2400
ALL SQUARE 1**



Date size:
3mm

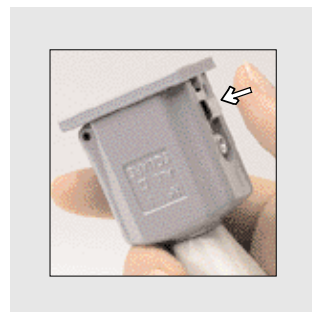
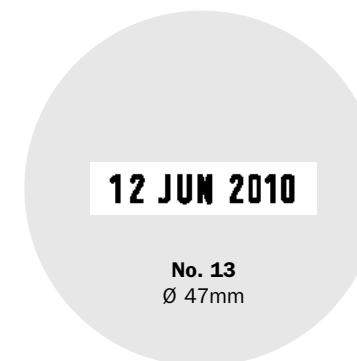
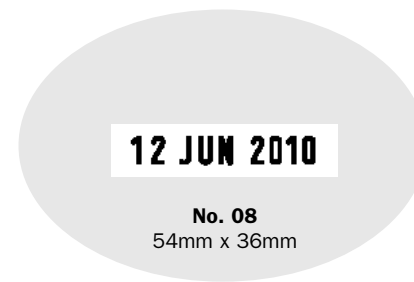
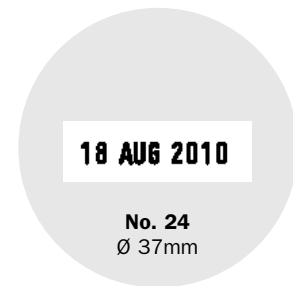
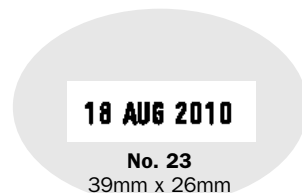

Setting the date:

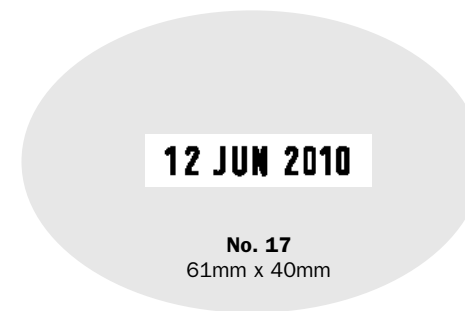

**2410
ALL SQUARE 2**



Date size:
4mm

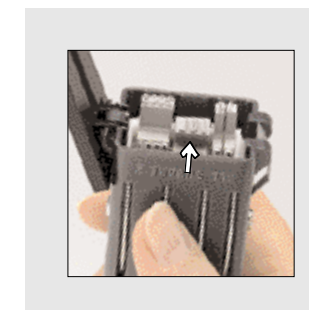
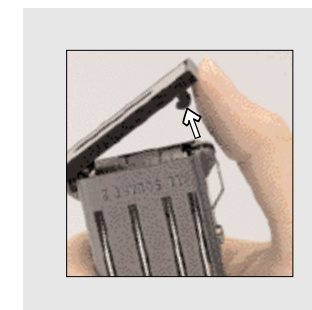
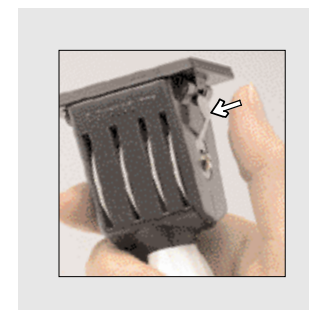

Setting the date:



DATE + TEXT

Reliable – traditional and economical daters in a durable plastic frame which combine a changeable 4mm date with the wordings 'PAID' or 'RECEIVED'

2210

Date size: 4mm



max. 47mm x 30mm

2210/L

Date size: 4mm



2210/L1 Received



max. 47mm x 30mm

2210/L2 Paid



max. 47mm x 30mm

2330/L Plastic frame



Date size: 4mm



L1:



44mm x 29mm

Also available:
L2: RECEIVED

2226

Date size: 4mm

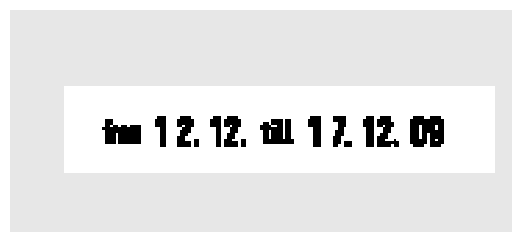

Double dater with textplate. Max. 67mm x 30mm

DATERS

1000 – 1020 Metal frame



1000, 1010, 1020



| | | |
|-----------------|----------------|---------------------|
| 1000 | Date size: 3mm | 14 DEC 2010 |
| 1010 | Date size: 4mm | 14 DEC 2010 |
| 1010 MA | Date size: 4mm | 14 -10- 2010 |
| 1010 ISO | Date size: 4mm | 2010 -02-10 |
| 1014 | Date size: 4mm | 18.05.09 |
| 1020 | Date size: 5mm | 14 DEC 2010 |
| 1020 ISO | Date size: 5mm | 2010 -10- 20 |

1210 Plastic frame

sturdy plastic frame



14 DEC 2010
Date size: 4mm

DIAL-A-PHRASE DATERS, DATE + TEXT

12 of the most popular office phrases combined with a 4mm date on a rubber stamp – essential for office organisation

1117 & 1117/L Metal frame



Date size: 4mm



1117 – Other texts:

- ANSWERED
- BACKORDERED
- CANCELLED
- BILLED
- RECEIVED
- CHARGED
- CHECKED
- DELIVERED
- ENTERED
- PAID
- SHIPPED
- FAXED

1117/L – Other texts:

- ANSWERED
- SUPPLY BY
- CANCELLED
- ORDERED
- INVOICED
- CHECKED
- ACKNOWL'D
- TELEPHONED
- PAID
- RECEIVED
- DELIVERED
- ENTERED

1117
PAID 14 DEC 2010

1117/L
CHECKED 14 DEC 2010

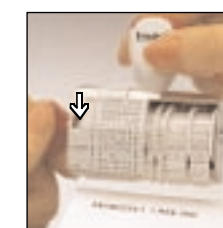

Select a phrase, turn the key until reference number appears in the window; the selected phrase is ready for stamping.



Standard version: 4, 6, 8, 10 and 12 bands. You may customise your numberer with letter bands (A-M and N-Z) and/or with special bands (letters, numbers or symbols as required)

| | | |
|-------|---------------------|---|
| 1534 | Character size: 3mm | 1 2 3 1 |
| 1536 | Character size: 3mm | 1 2 3 1 2 3 |
| 1538 | Character size: 3mm | 1 2 3 1 2 3 1 2 |
| 15310 | Character size: 3mm | 1 2 3 1 2 3 1 2 3 1 |
| 15312 | Character size: 3mm | 1 2 3 1 2 3 1 2 3 1 2 3 |
| 15320 | Character size: 3mm | 1 2 3 1 2 3 1 2 3 1 2 3 1 2 3 1 2 3 1 2 3 1 2 3 |
| 1544 | Character size: 4mm | 1 2 3 1 |
| 1546 | Character size: 4mm | 1 2 3 1 2 3 |
| 1548 | Character size: 4mm | 1 2 3 1 2 3 1 2 |
| 15410 | Character size: 4mm | 1 2 3 1 2 3 1 2 3 1 |
| 15412 | Character size: 4mm | 1 2 3 1 2 3 1 2 3 1 2 3 |
| 1554 | Character size: 5mm | 1 2 3 1 |
| 1556 | Character size: 5mm | 1 2 3 1 2 3 |
| 1558 | Character size: 5mm | 1 2 3 1 2 3 1 2 |
| 15510 | Character size: 5mm | 1 2 3 1 2 3 1 2 3 1 |
| 15512 | Character size: 5mm | 1 2 3 1 2 3 1 2 3 1 2 3 |
| 15514 | Character size: 5mm | 1 2 3 1 2 3 1 2 3 1 2 3 1 2 |
| 1574 | Character size: 7mm | 1 2 3 1 |
| 1576 | Character size: 7mm | 1 2 3 1 2 3 |
| 1578 | Character size: 7mm | 1 2 3 1 2 3 1 2 |
| 1594 | Character size: 9mm | 1 2 3 1 |
| 1596 | Character size: 9mm | 1 2 3 1 2 3 |
| 1598 | Character size: 9mm | 1 2 3 1 2 3 1 2 |
| 15910 | Character size: 9mm | 1 2 3 1 2 3 1 2 3 1 |
| 15912 | Character size: 9mm | 1 2 3 1 2 3 1 2 3 1 2 3 |

15124 Character size: 12mm

1 2 3 1 1 2 3 1 2 3 1 2

15126 Character size: 12mm

15128 Character size: 12mm

15154 Character size: 15mm

15156 Character size: 15mm

15158 Character size: 15mm

1 2 3 1 2 3 1 2

15184 Character size: 18mm

15186 Character size: 18mm

1 2 3 1 1 2

15188 Character size: 18mm

151810 Character size: 18mm

1 2 3 1 2 3 1 2 1 2

The bands are supplied with the following numbers and symbols:

| <table border="1"> <thead><tr><th>Prod. code.</th><th>Char. size</th></tr></thead> <tbody> <tr><td>1534</td><td>3</td></tr> <tr><td>1544</td><td>4</td></tr> <tr><td>1554</td><td>5</td></tr> <tr><td>1574</td><td>7</td></tr> <tr><td>1594</td><td>9</td></tr> <tr><td>15124</td><td>12</td></tr> </tbody> </table> | Prod. code. | Char. size | 1534 | 3 | 1544 | 4 | 1554 | 5 | 1574 | 7 | 1594 | 9 | 15124 | 12 | <table border="1"> <thead><tr><th colspan="4">Number of bands</th></tr><tr><th>1</th><th>2</th><th>3</th><th>4</th></tr></thead> <tbody> <tr><td>0-9</td><td>0-9</td><td>0-9</td><td>0-9</td></tr> <tr><td>N°</td><td>/</td><td>Kg</td><td>,</td></tr> <tr><td>€</td><td>-</td><td>%</td><td>F</td></tr> <tr><td>#</td><td>.</td><td>/</td><td>¢</td></tr> <tr><td>\$</td><td></td><td></td><td></td></tr> </tbody> </table> | Number of bands | | | | 1 | 2 | 3 | 4 | 0-9 | 0-9 | 0-9 | 0-9 | N° | / | Kg | , | € | - | % | F | # | . | / | ¢ | \$ | | | | <table border="1"> <thead><tr><th>Prod. code.</th><th>Char. size</th></tr></thead> <tbody> <tr><td>15154</td><td>15</td></tr> <tr><td>15184</td><td>18</td></tr> </tbody> </table> | Prod. code. | Char. size | 15154 | 15 | 15184 | 18 | <table border="1"> <thead><tr><th colspan="4">Number of bands</th></tr><tr><th>1</th><th>2</th><th>3</th><th>4</th></tr></thead> <tbody> <tr><td>0-9</td><td>0-9</td><td>0-9</td><td>0-9</td></tr> <tr><td>N°</td><td>3/4</td><td>1/4</td><td>F</td></tr> <tr><td>St.</td><td>-</td><td>1/2</td><td>/</td></tr> </tbody> </table> | Number of bands | | | | 1 | 2 | 3 | 4 | 0-9 | 0-9 | 0-9 | 0-9 | N° | 3/4 | 1/4 | F | St. | - | 1/2 | / | | | | | | | | | | | | | | | | | | | | | | | | |
|--|-------------|------------|-------|-----|-------|---|-------|---|-------|---|---|-----------------|-------|----|--|-----------------|----|----|----|-----|-----|-----|-----|-----|-----|-----|-----|-----|-----|-----|-----|-----|-----|----|---|--|-------------|------------|--------|----|--|-----------------|------|--|-------------|------------|--|-------------|------------|-------|---|---|-----------------|------|-----|-----|-----|--|-------------|------------|-------|-----|-------|-----|---|-----------------|---|-----|---|-----|-----|---|-----|---|---|---|---|-----|-----|-----|-----|-----|-----|----|---|---|---|-----|-----|-----|---|---|---|---|-----|
| Prod. code. | Char. size | | | | | | | | | | | | | | | | | | | | | | | | | | | | | | | | | | | | | | | | | | | | | | | | | | | | | | | | | | | | | | | | | | | | | | | | | | | | | | | | | | | | | | | | | | | | | | |
| 1534 | 3 | | | | | | | | | | | | | | | | | | | | | | | | | | | | | | | | | | | | | | | | | | | | | | | | | | | | | | | | | | | | | | | | | | | | | | | | | | | | | | | | | | | | | | | | | | | | | | |
| 1544 | 4 | | | | | | | | | | | | | | | | | | | | | | | | | | | | | | | | | | | | | | | | | | | | | | | | | | | | | | | | | | | | | | | | | | | | | | | | | | | | | | | | | | | | | | | | | | | | | | |
| 1554 | 5 | | | | | | | | | | | | | | | | | | | | | | | | | | | | | | | | | | | | | | | | | | | | | | | | | | | | | | | | | | | | | | | | | | | | | | | | | | | | | | | | | | | | | | | | | | | | | | |
| 1574 | 7 | | | | | | | | | | | | | | | | | | | | | | | | | | | | | | | | | | | | | | | | | | | | | | | | | | | | | | | | | | | | | | | | | | | | | | | | | | | | | | | | | | | | | | | | | | | | | | |
| 1594 | 9 | | | | | | | | | | | | | | | | | | | | | | | | | | | | | | | | | | | | | | | | | | | | | | | | | | | | | | | | | | | | | | | | | | | | | | | | | | | | | | | | | | | | | | | | | | | | | | |
| 15124 | 12 | | | | | | | | | | | | | | | | | | | | | | | | | | | | | | | | | | | | | | | | | | | | | | | | | | | | | | | | | | | | | | | | | | | | | | | | | | | | | | | | | | | | | | | | | | | | | | |
| Number of bands | | | | | | | | | | | | | | | | | | | | | | | | | | | | | | | | | | | | | | | | | | | | | | | | | | | | | | | | | | | | | | | | | | | | | | | | | | | | | | | | | | | | | | | | | | | | | | | |
| 1 | 2 | 3 | 4 | | | | | | | | | | | | | | | | | | | | | | | | | | | | | | | | | | | | | | | | | | | | | | | | | | | | | | | | | | | | | | | | | | | | | | | | | | | | | | | | | | | | | | | | | | | | |
| 0-9 | 0-9 | 0-9 | 0-9 | | | | | | | | | | | | | | | | | | | | | | | | | | | | | | | | | | | | | | | | | | | | | | | | | | | | | | | | | | | | | | | | | | | | | | | | | | | | | | | | | | | | | | | | | | | | |
| N° | / | Kg | , | | | | | | | | | | | | | | | | | | | | | | | | | | | | | | | | | | | | | | | | | | | | | | | | | | | | | | | | | | | | | | | | | | | | | | | | | | | | | | | | | | | | | | | | | | | | |
| € | - | % | F | | | | | | | | | | | | | | | | | | | | | | | | | | | | | | | | | | | | | | | | | | | | | | | | | | | | | | | | | | | | | | | | | | | | | | | | | | | | | | | | | | | | | | | | | | | | |
| # | . | / | ¢ | | | | | | | | | | | | | | | | | | | | | | | | | | | | | | | | | | | | | | | | | | | | | | | | | | | | | | | | | | | | | | | | | | | | | | | | | | | | | | | | | | | | | | | | | | | | |
| \$ | | | | | | | | | | | | | | | | | | | | | | | | | | | | | | | | | | | | | | | | | | | | | | | | | | | | | | | | | | | | | | | | | | | | | | | | | | | | | | | | | | | | | | | | | | | | | | | |
| Prod. code. | Char. size | | | | | | | | | | | | | | | | | | | | | | | | | | | | | | | | | | | | | | | | | | | | | | | | | | | | | | | | | | | | | | | | | | | | | | | | | | | | | | | | | | | | | | | | | | | | | | |
| 15154 | 15 | | | | | | | | | | | | | | | | | | | | | | | | | | | | | | | | | | | | | | | | | | | | | | | | | | | | | | | | | | | | | | | | | | | | | | | | | | | | | | | | | | | | | | | | | | | | | | |
| 15184 | 18 | | | | | | | | | | | | | | | | | | | | | | | | | | | | | | | | | | | | | | | | | | | | | | | | | | | | | | | | | | | | | | | | | | | | | | | | | | | | | | | | | | | | | | | | | | | | | | |
| Number of bands | | | | | | | | | | | | | | | | | | | | | | | | | | | | | | | | | | | | | | | | | | | | | | | | | | | | | | | | | | | | | | | | | | | | | | | | | | | | | | | | | | | | | | | | | | | | | | | |
| 1 | 2 | 3 | 4 | | | | | | | | | | | | | | | | | | | | | | | | | | | | | | | | | | | | | | | | | | | | | | | | | | | | | | | | | | | | | | | | | | | | | | | | | | | | | | | | | | | | | | | | | | | | |
| 0-9 | 0-9 | 0-9 | 0-9 | | | | | | | | | | | | | | | | | | | | | | | | | | | | | | | | | | | | | | | | | | | | | | | | | | | | | | | | | | | | | | | | | | | | | | | | | | | | | | | | | | | | | | | | | | | | |
| N° | 3/4 | 1/4 | F | | | | | | | | | | | | | | | | | | | | | | | | | | | | | | | | | | | | | | | | | | | | | | | | | | | | | | | | | | | | | | | | | | | | | | | | | | | | | | | | | | | | | | | | | | | | |
| St. | - | 1/2 | / | | | | | | | | | | | | | | | | | | | | | | | | | | | | | | | | | | | | | | | | | | | | | | | | | | | | | | | | | | | | | | | | | | | | | | | | | | | | | | | | | | | | | | | | | | | | |
| <table border="1"> <thead><tr><th>Prod. code.</th><th>Char. size</th></tr></thead> <tbody> <tr><td>1536</td><td>3</td></tr> <tr><td>1546</td><td>4</td></tr> <tr><td>1556</td><td>5</td></tr> <tr><td>1576</td><td>7</td></tr> <tr><td>1596</td><td>9</td></tr> <tr><td>15126</td><td>12</td></tr> </tbody> </table> | Prod. code. | Char. size | 1536 | 3 | 1546 | 4 | 1556 | 5 | 1576 | 7 | 1596 | 9 | 15126 | 12 | <table border="1"> <thead><tr><th colspan="6">Number of bands</th></tr><tr><th>1</th><th>2</th><th>3</th><th>4</th><th>5</th><th>6</th></tr></thead> <tbody> <tr><td>0-9</td><td>0-9</td><td>0-9</td><td>0-9</td><td>0-9</td><td>0-9</td></tr> <tr><td>N°</td><td>/</td><td>/</td><td>,</td><td>1/4</td><td>Kg</td></tr> <tr><td>€</td><td>-</td><td>-</td><td>F</td><td>1/2</td><td>%</td></tr> <tr><td>#</td><td>.</td><td>X</td><td>¢</td><td>3/4</td><td>/</td></tr> <tr><td>\$</td><td></td><td></td><td></td><td></td><td></td></tr> </tbody> </table> | Number of bands | | | | | | 1 | 2 | 3 | 4 | 5 | 6 | 0-9 | 0-9 | 0-9 | 0-9 | 0-9 | 0-9 | N° | / | / | , | 1/4 | Kg | € | - | - | F | 1/2 | % | # | . | X | ¢ | 3/4 | / | \$ | | | | | | <table border="1"> <thead><tr><th>Prod. code.</th><th>Char. size</th></tr></thead> <tbody> <tr><td>15156</td><td>15</td></tr> <tr><td>15186</td><td>18</td></tr> </tbody> </table> | Prod. code. | Char. size | 15156 | 15 | 15186 | 18 | <table border="1"> <thead><tr><th colspan="6">Number of bands</th></tr><tr><th>1</th><th>2</th><th>3</th><th>4</th><th>5</th><th>6</th></tr></thead> <tbody> <tr><td>0-9</td><td>0-9</td><td>0-9</td><td>0-9</td><td>0-9</td><td>0-9</td></tr> <tr><td>N°</td><td>/</td><td>X</td><td>F</td><td>3/4</td><td>1/4</td></tr> <tr><td>St.</td><td>.</td><td>,</td><td>/</td><td>-</td><td>1/2</td></tr> </tbody> </table> | Number of bands | | | | | | 1 | 2 | 3 | 4 | 5 | 6 | 0-9 | 0-9 | 0-9 | 0-9 | 0-9 | 0-9 | N° | / | X | F | 3/4 | 1/4 | St. | . | , | / | - | 1/2 |
| Prod. code. | Char. size | | | | | | | | | | | | | | | | | | | | | | | | | | | | | | | | | | | | | | | | | | | | | | | | | | | | | | | | | | | | | | | | | | | | | | | | | | | | | | | | | | | | | | | | | | | | | | |
| 1536 | 3 | | | | | | | | | | | | | | | | | | | | | | | | | | | | | | | | | | | | | | | | | | | | | | | | | | | | | | | | | | | | | | | | | | | | | | | | | | | | | | | | | | | | | | | | | | | | | | |
| 1546 | 4 | | | | | | | | | | | | | | | | | | | | | | | | | | | | | | | | | | | | | | | | | | | | | | | | | | | | | | | | | | | | | | | | | | | | | | | | | | | | | | | | | | | | | | | | | | | | | | |
| 1556 | 5 | | | | | | | | | | | | | | | | | | | | | | | | | | | | | | | | | | | | | | | | | | | | | | | | | | | | | | | | | | | | | | | | | | | | | | | | | | | | | | | | | | | | | | | | | | | | | | |
| 1576 | 7 | | | | | | | | | | | | | | | | | | | | | | | | | | | | | | | | | | | | | | | | | | | | | | | | | | | | | | | | | | | | | | | | | | | | | | | | | | | | | | | | | | | | | | | | | | | | | | |
| 1596 | 9 | | | | | | | | | | | | | | | | | | | | | | | | | | | | | | | | | | | | | | | | | | | | | | | | | | | | | | | | | | | | | | | | | | | | | | | | | | | | | | | | | | | | | | | | | | | | | | |
| 15126 | 12 | | | | | | | | | | | | | | | | | | | | | | | | | | | | | | | | | | | | | | | | | | | | | | | | | | | | | | | | | | | | | | | | | | | | | | | | | | | | | | | | | | | | | | | | | | | | | | |
| Number of bands | | | | | | | | | | | | | | | | | | | | | | | | | | | | | | | | | | | | | | | | | | | | | | | | | | | | | | | | | | | | | | | | | | | | | | | | | | | | | | | | | | | | | | | | | | | | | | | |
| 1 | 2 | 3 | 4 | 5 | 6 | | | | | | | | | | | | | | | | | | | | | | | | | | | | | | | | | | | | | | | | | | | | | | | | | | | | | | | | | | | | | | | | | | | | | | | | | | | | | | | | | | | | | | | | | | |
| 0-9 | 0-9 | 0-9 | 0-9 | 0-9 | 0-9 | | | | | | | | | | | | | | | | | | | | | | | | | | | | | | | | | | | | | | | | | | | | | | | | | | | | | | | | | | | | | | | | | | | | | | | | | | | | | | | | | | | | | | | | | | |
| N° | / | / | , | 1/4 | Kg | | | | | | | | | | | | | | | | | | | | | | | | | | | | | | | | | | | | | | | | | | | | | | | | | | | | | | | | | | | | | | | | | | | | | | | | | | | | | | | | | | | | | | | | | | |
| € | - | - | F | 1/2 | % | | | | | | | | | | | | | | | | | | | | | | | | | | | | | | | | | | | | | | | | | | | | | | | | | | | | | | | | | | | | | | | | | | | | | | | | | | | | | | | | | | | | | | | | | | |
| # | . | X | ¢ | 3/4 | / | | | | | | | | | | | | | | | | | | | | | | | | | | | | | | | | | | | | | | | | | | | | | | | | | | | | | | | | | | | | | | | | | | | | | | | | | | | | | | | | | | | | | | | | | | |
| \$ | | | | | | | | | | | | | | | | | | | | | | | | | | | | | | | | | | | | | | | | | | | | | | | | | | | | | | | | | | | | | | | | | | | | | | | | | | | | | | | | | | | | | | | | | | | | | | | |
| Prod. code. | Char. size | | | | | | | | | | | | | | | | | | | | | | | | | | | | | | | | | | | | | | | | | | | | | | | | | | | | | | | | | | | | | | | | | | | | | | | | | | | | | | | | | | | | | | | | | | | | | | |
| 15156 | 15 | | | | | | | | | | | | | | | | | | | | | | | | | | | | | | | | | | | | | | | | | | | | | | | | | | | | | | | | | | | | | | | | | | | | | | | | | | | | | | | | | | | | | | | | | | | | | | |
| 15186 | 18 | | | | | | | | | | | | | | | | | | | | | | | | | | | | | | | | | | | | | | | | | | | | | | | | | | | | | | | | | | | | | | | | | | | | | | | | | | | | | | | | | | | | | | | | | | | | | | |
| Number of bands | | | | | | | | | | | | | | | | | | | | | | | | | | | | | | | | | | | | | | | | | | | | | | | | | | | | | | | | | | | | | | | | | | | | | | | | | | | | | | | | | | | | | | | | | | | | | | | |
| 1 | 2 | 3 | 4 | 5 | 6 | | | | | | | | | | | | | | | | | | | | | | | | | | | | | | | | | | | | | | | | | | | | | | | | | | | | | | | | | | | | | | | | | | | | | | | | | | | | | | | | | | | | | | | | | | |
| 0-9 | 0-9 | 0-9 | 0-9 | 0-9 | 0-9 | | | | | | | | | | | | | | | | | | | | | | | | | | | | | | | | | | | | | | | | | | | | | | | | | | | | | | | | | | | | | | | | | | | | | | | | | | | | | | | | | | | | | | | | | | |
| N° | / | X | F | 3/4 | 1/4 | | | | | | | | | | | | | | | | | | | | | | | | | | | | | | | | | | | | | | | | | | | | | | | | | | | | | | | | | | | | | | | | | | | | | | | | | | | | | | | | | | | | | | | | | | |
| St. | . | , | / | - | 1/2 | | | | | | | | | | | | | | | | | | | | | | | | | | | | | | | | | | | | | | | | | | | | | | | | | | | | | | | | | | | | | | | | | | | | | | | | | | | | | | | | | | | | | | | | | | |
| <table border="1"> <thead><tr><th>Prod. code.</th><th>Char. size</th></tr></thead> <tbody> <tr><td>1538</td><td>3</td></tr> <tr><td>1548</td><td>4</td></tr> <tr><td>1558</td><td>5</td></tr> <tr><td>1578</td><td>7</td></tr> <tr><td>1598</td><td>9</td></tr> <tr><td>15128</td><td>12</td></tr> </tbody> </table> | Prod. code. | Char. size | 1538 | 3 | 1548 | 4 | 1558 | 5 | 1578 | 7 | 1598 | 9 | 15128 | 12 | <table border="1"> <thead><tr><th colspan="6">Number of bands</th></tr><tr><th>1</th><th>2-4</th><th>5</th><th>6</th><th>7</th><th>8</th></tr></thead> <tbody> <tr><td>0-9</td><td>0-9</td><td>0-9</td><td>0-9</td><td>0-9</td><td>0-9</td></tr> <tr><td>N°</td><td>/</td><td>/</td><td>,</td><td>1/4</td><td>Kg</td></tr> <tr><td>€</td><td>-</td><td>-</td><td>F</td><td>1/2</td><td>%</td></tr> <tr><td>#</td><td>.</td><td>X</td><td>¢</td><td>3/4</td><td>/</td></tr> <tr><td>\$</td><td></td><td></td><td></td><td></td><td></td></tr> </tbody> </table> | Number of bands | | | | | | 1 | 2-4 | 5 | 6 | 7 | 8 | 0-9 | 0-9 | 0-9 | 0-9 | 0-9 | 0-9 | N° | / | / | , | 1/4 | Kg | € | - | - | F | 1/2 | % | # | . | X | ¢ | 3/4 | / | \$ | | | | | | <table border="1"> <thead><tr><th>Prod. code.</th><th>Char. size</th></tr></thead> <tbody> <tr><td>15158</td><td>15</td></tr> <tr><td>15188</td><td>18</td></tr> </tbody> </table> | Prod. code. | Char. size | 15158 | 15 | 15188 | 18 | <table border="1"> <thead><tr><th colspan="6">Number of bands</th></tr><tr><th>1</th><th>2-4</th><th>5</th><th>6</th><th>7</th><th>8</th></tr></thead> <tbody> <tr><td>0-9</td><td>0-9</td><td>0-9</td><td>0-9</td><td>0-9</td><td>0-9</td></tr> <tr><td>N°</td><td>/</td><td>X</td><td>F</td><td>3/4</td><td>1/4</td></tr> <tr><td>St.</td><td>.</td><td>,</td><td>/</td><td>-</td><td>1/2</td></tr> </tbody> </table> | Number of bands | | | | | | 1 | 2-4 | 5 | 6 | 7 | 8 | 0-9 | 0-9 | 0-9 | 0-9 | 0-9 | 0-9 | N° | / | X | F | 3/4 | 1/4 | St. | . | , | / | - | 1/2 |
| Prod. code. | Char. size | | | | | | | | | | | | | | | | | | | | | | | | | | | | | | | | | | | | | | | | | | | | | | | | | | | | | | | | | | | | | | | | | | | | | | | | | | | | | | | | | | | | | | | | | | | | | | |
| 1538 | 3 | | | | | | | | | | | | | | | | | | | | | | | | | | | | | | | | | | | | | | | | | | | | | | | | | | | | | | | | | | | | | | | | | | | | | | | | | | | | | | | | | | | | | | | | | | | | | | |
| 1548 | 4 | | | | | | | | | | | | | | | | | | | | | | | | | | | | | | | | | | | | | | | | | | | | | | | | | | | | | | | | | | | | | | | | | | | | | | | | | | | | | | | | | | | | | | | | | | | | | | |
| 1558 | 5 | | | | | | | | | | | | | | | | | | | | | | | | | | | | | | | | | | | | | | | | | | | | | | | | | | | | | | | | | | | | | | | | | | | | | | | | | | | | | | | | | | | | | | | | | | | | | | |
| 1578 | 7 | | | | | | | | | | | | | | | | | | | | | | | | | | | | | | | | | | | | | | | | | | | | | | | | | | | | | | | | | | | | | | | | | | | | | | | | | | | | | | | | | | | | | | | | | | | | | | |
| 1598 | 9 | | | | | | | | | | | | | | | | | | | | | | | | | | | | | | | | | | | | | | | | | | | | | | | | | | | | | | | | | | | | | | | | | | | | | | | | | | | | | | | | | | | | | | | | | | | | | | |
| 15128 | 12 | | | | | | | | | | | | | | | | | | | | | | | | | | | | | | | | | | | | | | | | | | | | | | | | | | | | | | | | | | | | | | | | | | | | | | | | | | | | | | | | | | | | | | | | | | | | | | |
| Number of bands | | | | | | | | | | | | | | | | | | | | | | | | | | | | | | | | | | | | | | | | | | | | | | | | | | | | | | | | | | | | | | | | | | | | | | | | | | | | | | | | | | | | | | | | | | | | | | | |
| 1 | 2-4 | 5 | 6 | 7 | 8 | | | | | | | | | | | | | | | | | | | | | | | | | | | | | | | | | | | | | | | | | | | | | | | | | | | | | | | | | | | | | | | | | | | | | | | | | | | | | | | | | | | | | | | | | | |
| 0-9 | 0-9 | 0-9 | 0-9 | 0-9 | 0-9 | | | | | | | | | | | | | | | | | | | | | | | | | | | | | | | | | | | | | | | | | | | | | | | | | | | | | | | | | | | | | | | | | | | | | | | | | | | | | | | | | | | | | | | | | | |
| N° | / | / | , | 1/4 | Kg | | | | | | | | | | | | | | | | | | | | | | | | | | | | | | | | | | | | | | | | | | | | | | | | | | | | | | | | | | | | | | | | | | | | | | | | | | | | | | | | | | | | | | | | | | |
| € | - | - | F | 1/2 | % | | | | | | | | | | | | | | | | | | | | | | | | | | | | | | | | | | | | | | | | | | | | | | | | | | | | | | | | | | | | | | | | | | | | | | | | | | | | | | | | | | | | | | | | | | |
| # | . | X | ¢ | 3/4 | / | | | | | | | | | | | | | | | | | | | | | | | | | | | | | | | | | | | | | | | | | | | | | | | | | | | | | | | | | | | | | | | | | | | | | | | | | | | | | | | | | | | | | | | | | | |
| \$ | | | | | | | | | | | | | | | | | | | | | | | | | | | | | | | | | | | | | | | | | | | | | | | | | | | | | | | | | | | | | | | | | | | | | | | | | | | | | | | | | | | | | | | | | | | | | | | |
| Prod. code. | Char. size | | | | | | | | | | | | | | | | | | | | | | | | | | | | | | | | | | | | | | | | | | | | | | | | | | | | | | | | | | | | | | | | | | | | | | | | | | | | | | | | | | | | | | | | | | | | | | |
| 15158 | 15 | | | | | | | | | | | | | | | | | | | | | | | | | | | | | | | | | | | | | | | | | | | | | | | | | | | | | | | | | | | | | | | | | | | | | | | | | | | | | | | | | | | | | | | | | | | | | | |
| 15188 | 18 | | | | | | | | | | | | | | | | | | | | | | | | | | | | | | | | | | | | | | | | | | | | | | | | | | | | | | | | | | | | | | | | | | | | | | | | | | | | | | | | | | | | | | | | | | | | | | |
| Number of bands | | | | | | | | | | | | | | | | | | | | | | | | | | | | | | | | | | | | | | | | | | | | | | | | | | | | | | | | | | | | | | | | | | | | | | | | | | | | | | | | | | | | | | | | | | | | | | | |
| 1 | 2-4 | 5 | 6 | 7 | 8 | | | | | | | | | | | | | | | | | | | | | | | | | | | | | | | | | | | | | | | | | | | | | | | | | | | | | | | | | | | | | | | | | | | | | | | | | | | | | | | | | | | | | | | | | | |
| 0-9 | 0-9 | 0-9 | 0-9 | 0-9 | 0-9 | | | | | | | | | | | | | | | | | | | | | | | | | | | | | | | | | | | | | | | | | | | | | | | | | | | | | | | | | | | | | | | | | | | | | | | | | | | | | | | | | | | | | | | | | | |
| N° | / | X | F | 3/4 | 1/4 | | | | | | | | | | | | | | | | | | | | | | | | | | | | | | | | | | | | | | | | | | | | | | | | | | | | | | | | | | | | | | | | | | | | | | | | | | | | | | | | | | | | | | | | | | |
| St. | . | , | / | - | 1/2 | | | | | | | | | | | | | | | | | | | | | | | | | | | | | | | | | | | | | | | | | | | | | | | | | | | | | | | | | | | | | | | | | | | | | | | | | | | | | | | | | | | | | | | | | | |
| <table border="1"> <thead><tr><th>Prod. code.</th><th>Char. size</th></tr></thead> <tbody> <tr><td>15310</td><td>3</td></tr> <tr><td>15410</td><td>4</td></tr> <tr><td>15510</td><td>5</td></tr> <tr><td>15910</td><td>9</td></tr> </tbody> </table> | Prod. code. | Char. size | 15310 | 3 | 15410 | 4 | 15510 | 5 | 15910 | 9 | <table border="1"> <thead><tr><th colspan="4">Number of bands</th></tr><tr><th>1-7</th><th>8</th><th>8</th><th>10</th></tr></thead> <tbody> <tr><td>0-9</td><td>0-9</td><td>0-9</td><td>0-9</td></tr> <tr><td>/</td><td>,</td><td>/</td><td>/</td></tr> <tr><td>-</td><td>F</td><td>-</td><td>-</td></tr> <tr><td>.</td><td>¢</td><td>.</td><td>.</td></tr> </tbody> </table> | Number of bands | | | | 1-7 | 8 | 8 | 10 | 0-9 | 0-9 | 0-9 | 0-9 | / | , | / | / | - | F | - | - | . | ¢ | . | . | <table border="1"> <thead><tr><th>Prod. code.</th><th>Char. size</th></tr></thead> <tbody> <tr><td>151810</td><td>18</td></tr> </tbody> </table> | Prod. code. | Char. size | 151810 | 18 | <table border="1"> <thead><tr><th colspan="6">Number of bands</th></tr><tr><th>1</th><th>2-6</th><th>7</th><th>8</th><th>9</th><th>10</th></tr></thead> <tbody> <tr><td>0-9</td><td>0-9</td><td>0-9</td><td>0-9</td><td>0-9</td><td>0-9</td></tr> <tr><td>N°</td><td>/</td><td>X</td><td>F</td><td>3/4</td><td>1/4</td></tr> <tr><td>St.</td><td>.</td><td>,</td><td>/</td><td>-</td><td>1/2</td></tr> </tbody> </table> | Number of bands | | | | | | 1 | 2-6 | 7 | 8 | 9 | 10 | 0-9 | 0-9 | 0-9 | 0-9 | 0-9 | 0-9 | N° | / | X | F | 3/4 | 1/4 | St. | . | , | / | - | 1/2 | | | | | | | | | | | | | | | | | | | | | | | | |
| Prod. code. | Char. size | | | | | | | | | | | | | | | | | | | | | | | | | | | | | | | | | | | | | | | | | | | | | | | | | | | | | | | | | | | | | | | | | | | | | | | | | | | | | | | | | | | | | | | | | | | | | | |
| 15310 | 3 | | | | | | | | | | | | | | | | | | | | | | | | | | | | | | | | | | | | | | | | | | | | | | | | | | | | | | | | | | | | | | | | | | | | | | | | | | | | | | | | | | | | | | | | | | | | | | |
| 15410 | 4 | | | | | | | | | | | | | | | | | | | | | | | | | | | | | | | | | | | | | | | | | | | | | | | | | | | | | | | | | | | | | | | | | | | | | | | | | | | | | | | | | | | | | | | | | | | | | | |
| 15510 | 5 | | | | | | | | | | | | | | | | | | | | | | | | | | | | | | | | | | | | | | | | | | | | | | | | | | | | | | | | | | | | | | | | | | | | | | | | | | | | | | | | | | | | | | | | | | | | | | |
| 15910 | 9 | | | | | | | | | | | | | | | | | | | | | | | | | | | | | | | | | | | | | | | | | | | | | | | | | | | | | | | | | | | | | | | | | | | | | | | | | | | | | | | | | | | | | | | | | | | | | | |
| Number of bands | | | | | | | | | | | | | | | | | | | | | | | | | | | | | | | | | | | | | | | | | | | | | | | | | | | | | | | | | | | | | | | | | | | | | | | | | | | | | | | | | | | | | | | | | | | | | | | |
| 1-7 | 8 | 8 | 10 | | | | | | | | | | | | | | | | | | | | | | | | | | | | | | | | | | | | | | | | | | | | | | | | | | | | | | | | | | | | | | | | | | | | | | | | | | | | | | | | | | | | | | | | | | | | |
| 0-9 | 0-9 | 0-9 | 0-9 | | | | | | | | | | | | | | | | | | | | | | | | | | | | | | | | | | | | | | | | | | | | | | | | | | | | | | | | | | | | | | | | | | | | | | | | | | | | | | | | | | | | | | | | | | | | |
| / | , | / | / | | | | | | | | | | | | | | | | | | | | | | | | | | | | | | | | | | | | | | | | | | | | | | | | | | | | | | | | | | | | | | | | | | | | | | | | | | | | | | | | | | | | | | | | | | | | |
| - | F | - | - | | | | | | | | | | | | | | | | | | | | | | | | | | | | | | | | | | | | | | | | | | | | | | | | | | | | | | | | | | | | | | | | | | | | | | | | | | | | | | | | | | | | | | | | | | | | |
| . | ¢ | . | . | | | | | | | | | | | | | | | | | | | | | | | | | | | | | | | | | | | | | | | | | | | | | | | | | | | | | | | | | | | | | | | | | | | | | | | | | | | | | | | | | | | | | | | | | | | | |
| Prod. code. | Char. size | | | | | | | | | | | | | | | | | | | | | | | | | | | | | | | | | | | | | | | | | | | | | | | | | | | | | | | | | | | | | | | | | | | | | | | | | | | | | | | | | | | | | | | | | | | | | | |
| 151810 | 18 | | | | | | | | | | | | | | | | | | | | | | | | | | | | | | | | | | | | | | | | | | | | | | | | | | | | | | | | | | | | | | | | | | | | | | | | | | | | | | | | | | | | | | | | | | | | | | |
| Number of bands | | | | | | | | | | | | | | | | | | | | | | | | | | | | | | | | | | | | | | | | | | | | | | | | | | | | | | | | | | | | | | | | | | | | | | | | | | | | | | | | | | | | | | | | | | | | | | | |
| 1 | 2-6 | 7 | 8 | 9 | 10 | | | | | | | | | | | | | | | | | | | | | | | | | | | | | | | | | | | | | | | | | | | | | | | | | | | | | | | | | | | | | | | | | | | | | | | | | | | | | | | | | | | | | | | | | | |
| 0-9 | 0-9 | 0-9 | 0-9 | 0-9 | 0-9 | | | | | | | | | | | | | | | | | | | | | | | | | | | | | | | | | | | | | | | | | | | | | | | | | | | | | | | | | | | | | | | | | | | | | | | | | | | | | | | | | | | | | | | | | | |
| N° | / | X | F | 3/4 | 1/4 | | | | | | | | | | | | | | | | | | | | | | | | | | | | | | | | | | | | | | | | | | | | | | | | | | | | | | | | | | | | | | | | | | | | | | | | | | | | | | | | | | | | | | | | | | |
| St. | . | , | / | - | 1/2 | | | | | | | | | | | | | | | | | | | | | | | | | | | | | | | | | | | | | | | | | | | | | | | | | | | | | | | | | | | | | | | | | | | | | | | | | | | | | | | | | | | | | | | | | | |
| <table border="1"> <thead><tr><th>Prod. code.</th><th>Char. size</th></tr></thead> <tbody> <tr><td>15312</td><td>3</td></tr> <tr><td>15412</td><td>4</td></tr> <tr><td>15512</td><td>5</td></tr> <tr><td>15912</td><td>9</td></tr> </tbody> </table> | Prod. code. | Char. size | 15312 | 3 | 15412 | 4 | 15512 | 5 | 15912 | 9 | <table border="1"> <thead><tr><th colspan="4">Number of bands</th></tr><tr><th>1-9</th><th>10</th><th>11</th><th>12</th></tr></thead> <tbody> <tr><td>0-9</td><td>0-9</td><td>0-9</td><td>0-9</td></tr> <tr><td>/</td><td>,</td><td>/</td><td>/</td></tr> <tr><td>-</td><td>F</td><td>-</td><td>-</td></tr> <tr><td>.</td><td>¢</td><td>.</td><td>.</td></tr> </tbody> </table> | Number of bands | | | | 1-9 | 10 | 11 | 12 | 0-9 | 0-9 | 0-9 | 0-9 | / | , | / | / | - | F | - | - | . | ¢ | . | . | <table border="1"> <thead><tr><th>Prod. code.</th><th>Char. size</th></tr></thead> <tbody> <tr><td>15514</td><td>5</td></tr> </tbody> </table> | Prod. code. | Char. size | 15514 | 5 | <table border="1"> <thead><tr><th colspan="1">Number of bands</th></tr><tr><th>1-14</th></tr></thead> <tbody> <tr><td>0-9</td></tr> <tr><td>/</td></tr> <tr><td>.</td></tr> </tbody> </table> | Number of bands | 1-14 | 0-9 | / | . | <table border="1"> <thead><tr><th>Prod. code.</th><th>Char. size</th></tr></thead> <tbody> <tr><td>15320</td><td>3</td></tr> </tbody> </table> | Prod. code. | Char. size | 15320 | 3 | <table border="1"> <thead><tr><th colspan="1">Number of bands</th></tr><tr><th>1-20</th></tr></thead> <tbody> <tr><td>0-9</td></tr> <tr><td>/</td></tr> <tr><td>.</td></tr> </tbody> </table> | Number of bands | 1-20 | 0-9 | / | . | | | | | | | | | | | | | | | | | | | | | | | | | | | | | | | | | | | | | | |
| Prod. code. | Char. size | | | | | | | | | | | | | | | | | | | | | | | | | | | | | | | | | | | | | | | | | | | | | | | | | | | | | | | | | | | | | | | | | | | | | | | | | | | | | | | | | | | | | | | | | | | | | | |
| 15312 | 3 | | | | | | | | | | | | | | | | | | | | | | | | | | | | | | | | | | | | | | | | | | | | | | | | | | | | | | | | | | | | | | | | | | | | | | | | | | | | | | | | | | | | | | | | | | | | | | |
| 15412 | 4 | | | | | | | | | | | | | | | | | | | | | | | | | | | | | | | | | | | | | | | | | | | | | | | | | | | | | | | | | | | | | | | | | | | | | | | | | | | | | | | | | | | | | | | | | | | | | | |
| 15512 | 5 | | | | | | | | | | | | | | | | | | | | | | | | | | | | | | | | | | | | | | | | | | | | | | | | | | | | | | | | | | | | | | | | | | | | | | | | | | | | | | | | | | | | | | | | | | | | | | |
| 15912 | 9 | | | | | | | | | | | | | | | | | | | | | | | | | | | | | | | | | | | | | | | | | | | | | | | | | | | | | | | | | | | | | | | | | | | | | | | | | | | | | | | | | | | | | | | | | | | | | | |
| Number of bands | | | | | | | | | | | | | | | | | | | | | | | | | | | | | | | | | | | | | | | | | | | | | | | | | | | | | | | | | | | | | | | | | | | | | | | | | | | | | | | | | | | | | | | | | | | | | | | |
| 1-9 | 10 | 11 | 12 | | | | | | | | | | | | | | | | | | | | | | | | | | | | | | | | | | | | | | | | | | | | | | | | | | | | | | | | | | | | | | | | | | | | | | | | | | | | | | | | | | | | | | | | | | | | |
| 0-9 | 0-9 | 0-9 | 0-9 | | | | | | | | | | | | | | | | | | | | | | | | | | | | | | | | | | | | | | | | | | | | | | | | | | | | | | | | | | | | | | | | | | | | | | | | | | | | | | | | | | | | | | | | | | | | |
| / | , | / | / | | | | | | | | | | | | | | | | | | | | | | | | | | | | | | | | | | | | | | | | | | | | | | | | | | | | | | | | | | | | | | | | | | | | | | | | | | | | | | | | | | | | | | | | | | | | |
| - | F | - | - | | | | | | | | | | | | | | | | | | | | | | | | | | | | | | | | | | | | | | | | | | | | | | | | | | | | | | | | | | | | | | | | | | | | | | | | | | | | | | | | | | | | | | | | | | | | |
| . | ¢ | . | . | | | | | | | | | | | | | | | | | | | | | | | | | | | | | | | | | | | | | | | | | | | | | | | | | | | | | | | | | | | | | | | | | | | | | | | | | | | | | | | | | | | | | | | | | | | | |
| Prod. code. | Char. size | | | | | | | | | | | | | | | | | | | | | | | | | | | | | | | | | | | | | | | | | | | | | | | | | | | | | | | | | | | | | | | | | | | | | | | | | | | | | | | | | | | | | | | | | | | | | | |
| 15514 | 5 | | | | | | | | | | | | | | | | | | | | | | | | | | | | | | | | | | | | | | | | | | | | | | | | | | | | | | | | | | | | | | | | | | | | | | | | | | | | | | | | | | | | | | | | | | | | | | |
| Number of bands | | | | | | | | | | | | | | | | | | | | | | | | | | | | | | | | | | | | | | | | | | | | | | | | | | | | | | | | | | | | | | | | | | | | | | | | | | | | | | | | | | | | | | | | | | | | | | | |
| 1-14 | | | | | | | | | | | | | | | | | | | | | | | | | | | | | | | | | | | | | | | | | | | | | | | | | | | | | | | | | | | | | | | | | | | | | | | | | | | | | | | | | | | | | | | | | | | | | | | |
| 0-9 | | | | | | | | | | | | | | | | | | | | | | | | | | | | | | | | | | | | | | | | | | | | | | | | | | | | | | | | | | | | | | | | | | | | | | | | | | | | | | | | | | | | | | | | | | | | | | | |
| / | | | | | | | | | | | | | | | | | | | | | | | | | | | | | | | | | | | | | | | | | | | | | | | | | | | | | | | | | | | | | | | | | | | | | | | | | | | | | | | | | | | | | | | | | | | | | | | |
| . | | | | | | | | | | | | | | | | | | | | | | | | | | | | | | | | | | | | | | | | | | | | | | | | | | | | | | | | | | | | | | | | | | | | | | | | | | | | | | | | | | | | | | | | | | | | | | | |
| Prod. code. | Char. size | | | | | | | | | | | | | | | | | | | | | | | | | | | | | | | | | | | | | | | | | | | | | | | | | | | | | | | | | | | | | | | | | | | | | | | | | | | | | | | | | | | | | | | | | | | | | | |
| 15320 | 3 | | | | | | | | | | | | | | | | | | | | | | | | | | | | | | | | | | | | | | | | | | | | | | | | | | | | | | | | | | | | | | | | | | | | | | | | | | | | | | | | | | | | | | | | | | | | | | |
| Number of bands | | | | | | | | | | | | | | | | | | | | | | | | | | | | | | | | | | | | | | | | | | | | | | | | | | | | | | | | | | | | | | | | | | | | | | | | | | | | | | | | | | | | | | | | | | | | | | | |
| 1-20 | | | | | | | | | | | | | | | | | | | | | | | | | | | | | | | | | | | | | | | | | | | | | | | | | | | | | | | | | | | | | | | | | | | | | | | | | | | | | | | | | | | | | | | | | | | | | | | |
| 0-9 | | | | | | | | | | | | | | | | | | | | | | | | | | | | | | | | | | | | | | | | | | | | | | | | | | | | | | | | | | | | | | | | | | | | | | | | | | | | | | | | | | | | | | | | | | | | | | | |
| / | | | | | | | | | | | | | | | | | | | | | | | | | | | | | | | | | | | | | | | | | | | | | | | | | | | | | | | | | | | | | | | | | | | | | | | | | | | | | | | | | | | | | | | | | | | | | | | |
| . | | | | | | | | | | | | | | | | | | | | | | | | | | | | | | | | | | | | | | | | | | | | | | | | | | | | | | | | | | | | | | | | | | | | | | | | | | | | | | | | | | | | | | | | | | | | | | | |



TRODAT TWIN_

Not only is writing with the Twin a real pleasure, but the real surprise is the hidden self-inking stamp that is personalised just for you.

For your own use or as a gift, each and every Twin has its own character with a unique impression. Twin – a writing instrument and something more...

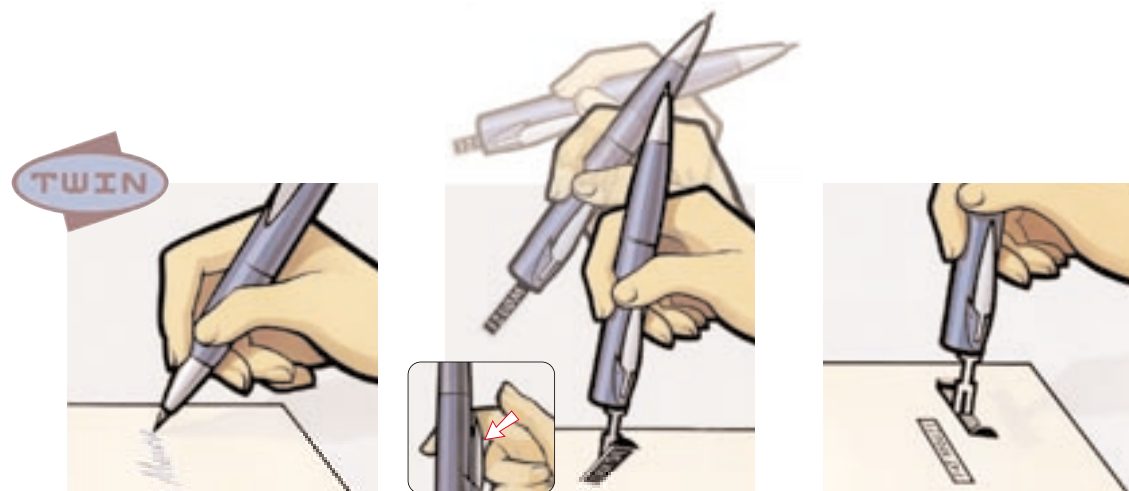

Twin_ The writing instrument that converts into a stamp in one simple move. Just turn the pen round 180°, press the clip and you're ready to stamp your chosen message.

COLOUR RANGE_



- 310171** – black
- 310176** – white
- 310180** – blue
- 310184** – red
- 310185** – orange

6/310 – Replacement pad; black
packed in 10's also available un-inked

307162 – Replacement refills D1 blue, packed in 5's

307165 – Replacement refills D1 black, packed in 5's

IMPRESSION SIZE_

max. 35mm x 7mm

textplate for max. 3 lines of text.
textplate thickness: 1.5mm



The Twin is packed individually as standard.

WRITE + STAMP_

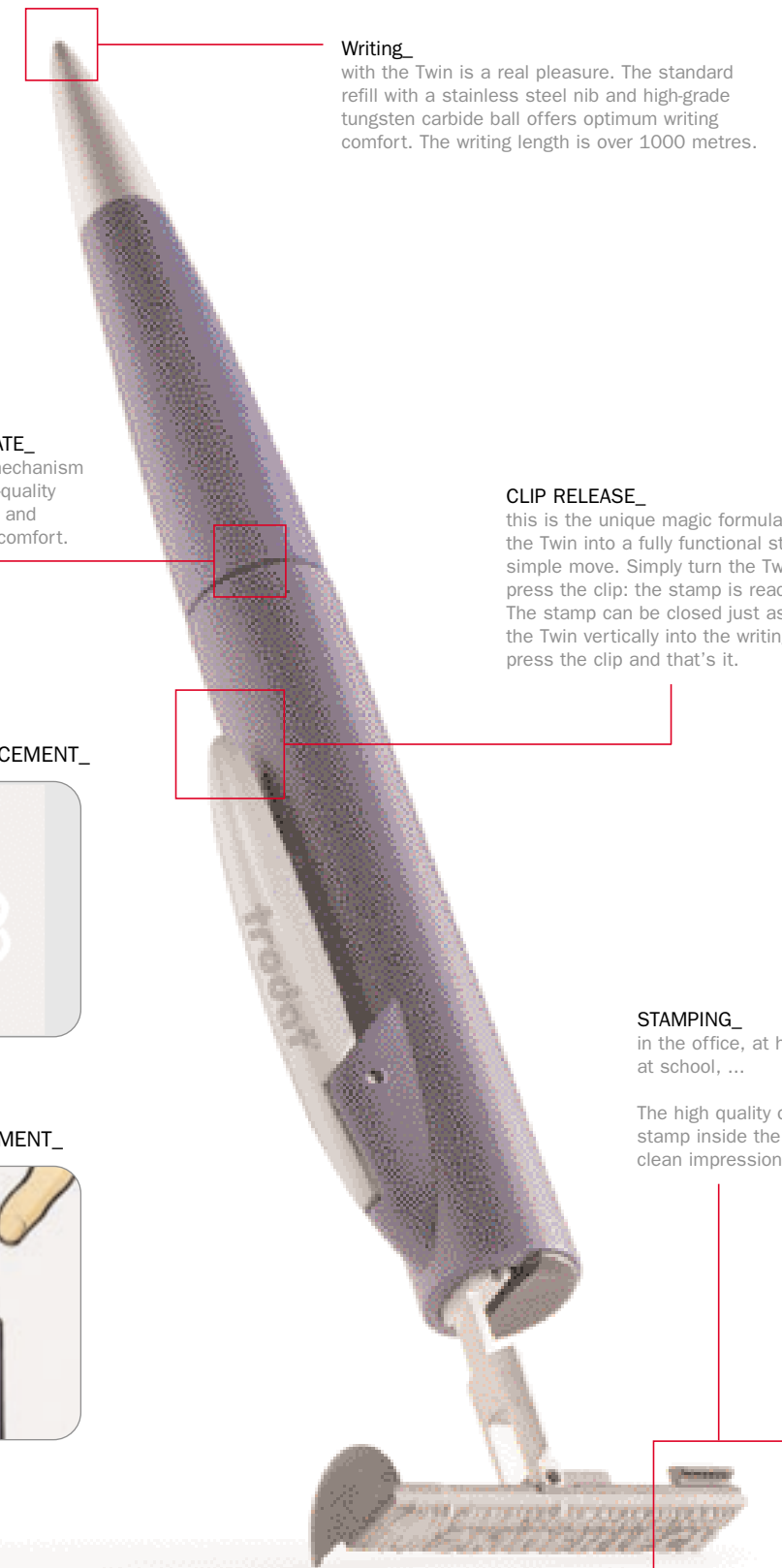

Writing_
with the Twin is a real pleasure. The standard refill with a stainless steel nib and high-grade tungsten carbide ball offers optimum writing comfort. The writing length is over 1000 metres.

A PLEASURE TO OPERATE_
the soft-switch turning mechanism which activates the high-quality Twin refill is easy to use and offers maximum writing comfort.

CLIP RELEASE_
this is the unique magic formula for converting the Twin into a fully functional stamp in one simple move. Simply turn the Twin 180° and press the clip: the stamp is ready for printing. The stamp can be closed just as easily: turn the Twin vertically into the writing position, press the clip and that's it.

REFILL REPLACEMENT_



PAD REPLACEMENT_



STAMPING_
in the office, at home, at parties, at school, ...

The high quality of the self-inking stamp inside the Twin makes a clean impression every time.

TRODAT MOBILE MARKER_

The pocket stamp in mini format. Make an impression on the move!



Nowadays, there is an ever-increasing need for flexibility and mobility. These demands are met by the new Mobile Marker. The pocket stamp in mini format with maximum impression.

MOBILE MARKER_



MINI FORMAT_
its small size – no bigger than a cigarette lighter – makes it easy and convenient to carry: it fits in any pocket.

MAXIMUM IMPRESSION_
the maximum impression size is 47mm x 18mm and allows up to 5 lines of text. The built-in pad with precise ink metering ensures a clean impression.

ATTRACTIVE DESIGN_
All component parts are fixed together to form a single stamp, so that it is fully secure.

Its attractive and unique design makes the Mobile Marker more than just a useful accessory.



SIZES AND COLOURS_

9412

max. 47mm x 18mm

Individual design options.
Textplate for up to 5 lines of text.

Please set textplate thickness to 2.3mm



translucent blue



translucent red



translucent grey



grey/white

WHEREVER YOU STAMP_



CLEAN & EASY TO USE_
the Mobile Marker is simple to use. Its innovative triangular format ensures stability when stamping.

PRACTICAL CLIP_
with its built-in clip, it can be easily attached to a jacket or trouser pocket.

MAXIMUM IMPRESSION_
the Mobile Marker allows for up to 5 lines of text and can be used like a business card.

TO OPEN: PRESS THE BUTTONS ON EACH SIDE

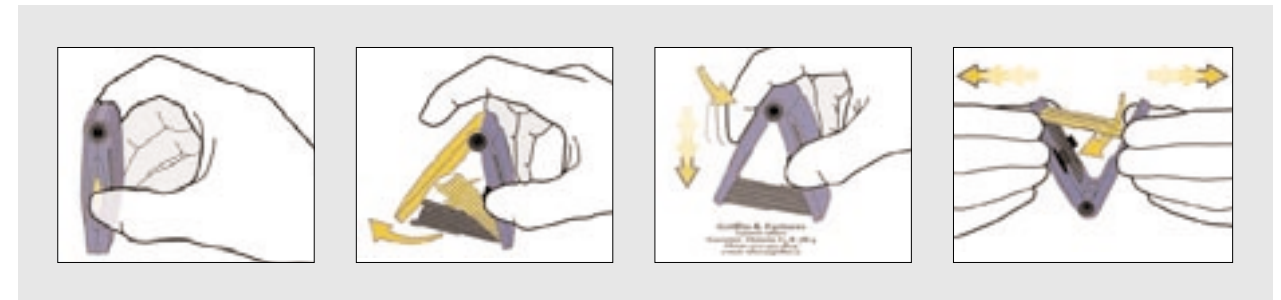

9412_
typo

Available in blue only



ROBERT NORMAN
EXPORT MANAGER
A-4000 WELS AUSTRIA
07242/239-0

For up to 4 lines of text, 1 letter set 6003 (3mm), 1 letter set 6004 (4mm)

4912 OFFICE PRINTY_

- in the New Printy design
- 2-colour impressions with pictogram and the most popular standard stock texts
- more stock texts available upon request



| | | | |
|---------------------|-----------------|--------------------|-----------------|
| PAID | PAID | FAXED | COPY |
| CONFIDENTIAL | FILE | FIRST CLASS | E-MAILED |
| RECEIVED | APPROVED | AIR MAIL | |

P970 STAMP STACK_

- This unique product features three popular titles in a handy stack.
- The individual stamps, each featuring a different word or phrase, clip together in any sequence, making Stamp Stack extremely versatile and easy to use.
- It is an ideal way to carry three different stamps in a bag or briefcase with no mess or fuss.
- The pre-inked material ensures that each stamp prints thousands of quality impressions.



| | | | |
|--|---|--|---|
| L1 PRIVATE & CONFIDENTIAL FAXED FILE COPY | L2 FIRST CLASS AIRMAIL POSTED | L3 CONFIDENTIAL COPY DRAFT | L4 CHECKED PASSED REJECTED |
| L5 VERY NEAT EXCELLENT GOOD WORK | L6 APPROVED FOR PAYMENT CONFIRMATION RECEIVED | L7 FOR YOUR INFORMATION CIRCULATE TO URGENT | L8 COPY INVOICE PAID THIS ACCOUNT IS NOW OVERDUE |

CLOTHING MARKER_ 4911 TYPO -

For marking textiles.

- non toxic
- easy to use
- washable & permanent up to 90°



MARK CUNNINGHAM
TEL. 01226 949432

max. 38mm x 14mm, max 3 lines of text

Content: 1 letter set 6004 (288 characters, character size 4mm), 1 pair of tweezers, 1 SWOP-PAD replacement pad, 1 stripe of fleece 60mm x 50mm

print

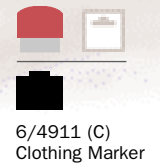

PRINTY 4910 WITH KEY RING_

Your permanent companion – always handy!



max. 26mm x 9mm



“VIENNA” POCKET STAMP_

Stamp comes with a small textplate, handy plastic box and stamp pad, available in two sizes.

9011
max. 39mm x 14mm



Pad colour: black or un-inked.

9012
max. 54mm x 18mm



POCKET SEALS_

- 1) 3610 - Pocket Seal with lock, chrome plated – (without die holder)
- 2) 3620 - Pocket Seal without lock, chrome plated – (without die holder)
- 3) 3630 - Small Desk Seal,
- 4) 3600/R - Die Holder, chrome plated Ø 41mm
- 5) 3600/E - Die Holder, chrome plated 25mm x 51mm
- 6) 3600/R51 - Die Holder, chrome plated Ø 51mm
- 7) 3640 - Delrin sheets (A4 format), 2mm. engraving material for male and female dies

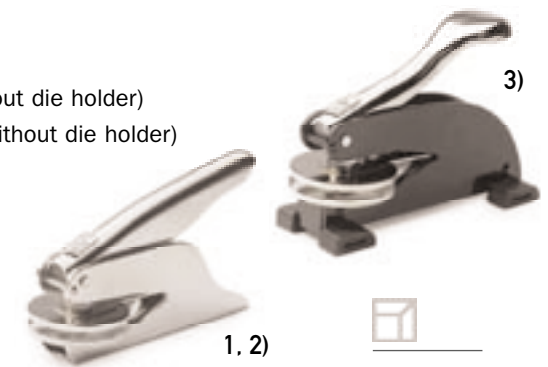

AUTOMATIC NUMBERING MACHINES_

- 1) 5756/P - plastic frame
- 2) 5756/M - metal frame

Date size: 5.5mm (metal wheels), 6 digits.

8 different adjustments: repeat (0), continuous (1), duplicate (2), repetition 3,4,5,6 or 12 times.

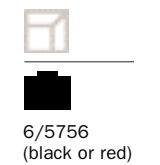
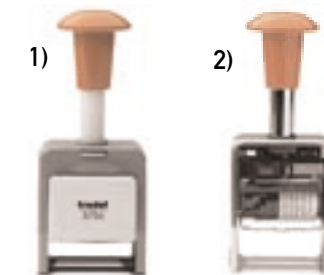

Not available in: UK, GR, N

**STAMP RACKS_**

The stamp rack for hand stamps.

**1) 3008**

holds 8 stamps (plastic)

2) 3014

holds 14 stamps (plastic)

3) 3010/M

holds 10 stamps (metal)

4) 3016/M

holds 16 stamps (metal)

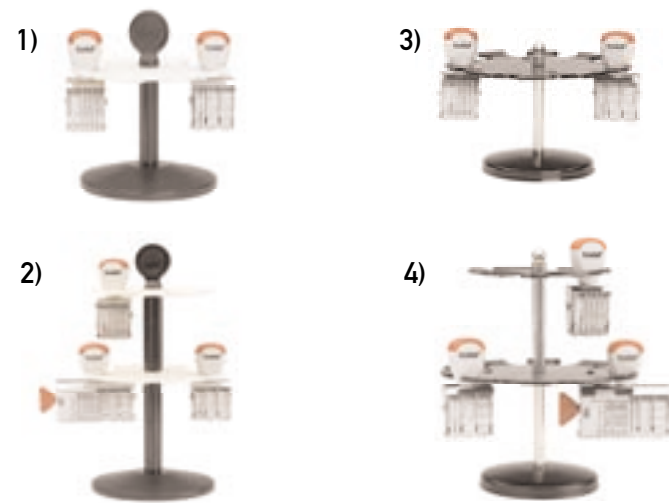
**STAMP PADS_**

Stamp pads in 3 sizes and a choice of colours: black, blue, red, violet and green.

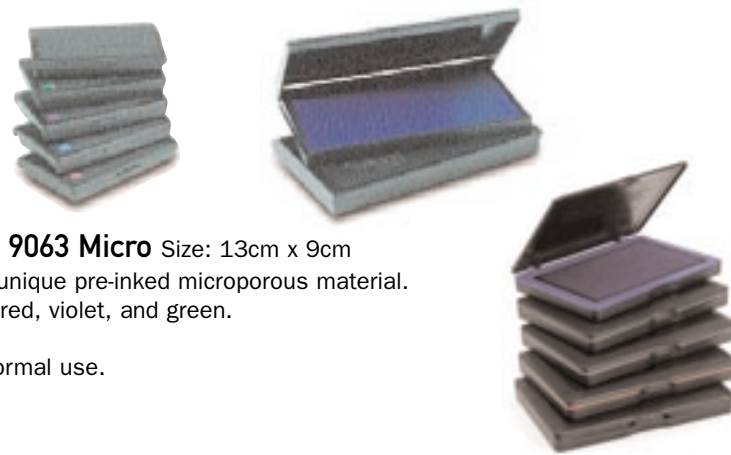
**1) 9051** Size: 9cm x 5cm**2) 9052** Size: 11cm x 7cm**3) 9053** Size: 16cm x 9cm**4) 9062 Micro** Size: 11cm x 7cm, **9063 Micro** Size: 13cm x 9cm

Micro Gel stamp pads made with a unique pre-inked microporous material. Available in the colours black, blue, red, violet, and green.

- Contain enough ink for years of normal use.
- No re-inking required.
- Secure snap-close plastic box.

STAMP INK_

Stamp ink to re-ink your stamp pad.

**7011** - 28ml

black, blue, red, violet and green

**7021** - quick drying, 25ml

black, blue, red, violet, green and white

**LASER RUBBER_**

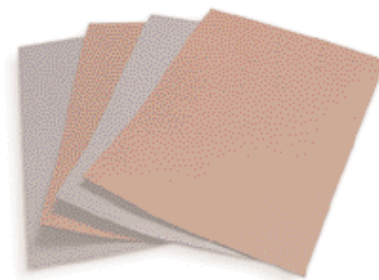

Laser sheets for textplate production

(ideal for use with a **Laser appliance** from **Trotec**)

850202/2.3 Laser rubber red, 2.3mm thick (A4, A3)**850203/2.3** Laser rubber black, 2.3mm thick, oil-resistant (A4)**850205/1.5** Laser rubber grey, 1.5mm thick, solvent-resistant. (A4)**850205/2.3** Laser rubber grey, 2.3mm thick, solvent-resistant (A4, A3)**850206/2.3** Laser Speed Rubber, 2.3mm thick, solvent-resistant (A4)**P800** Pre-inked laser rubber, black, 6mm thick (A4)

| | | | |
|--|--|--|--|
| | | | |
| TESTER DISPLAY PRINTY/ PROFESSIONAL LINE STANDARD ORDER REF. 3849 MCI ORDER REF. 5646 | SINGLE DISPLAY MCI ORDER REF. 86888 (without stamp) | WALL DISPLAY ORDER REF. 86887 | DISPLAY PRINTY 4912, 39 CM ORDER REF. 88746 |
| | | | |
| DISPLAY FOR BLISTER PACKS ORDER REF. 5795 CROWNER ENGLISH 5796 | POSTER MCI A1 ORDER REF. 4696 | POSTER MCI SMALL ORDER REF. 4695 | POSTER PROFESSIONAL LINE A2 IMAGE ORDER REF. 86879 |
| | | | |
| POSTER PROFESSIONAL LINE A2 TECHNICAL DETAILS ORDER REF. 88766 | POSTER PRINTY LINE A2 TECHNICAL DETAILS ORDER REF. 86892 | POSTER PRINTY LINE A2 HANDS ORDER REF. 86920 | POSTER BIG PRINTY A1 ORDER REF. 9046 |
| | | | |
| POSTER STAMPS A1 ORDER REF. 76059 | POSTER IMPRESSOR A2 ORDER REF. (ENGLISH): 84370 | POSTER TWIN A2 ORDER REF. 86946 | MCI STICKER MULTILING ORDER REF. FRONT: 4637 ORDER REF. BACK: 4639 |

| | | | |
|--|---|---|--|
| | | | |
| MCI STICKER SMALL ORDER REF 1 (20 à 2.2x4.3cm): 4667 ORDER REF 2 (18 à 1.4x2.3cm + 24 à 1.1x1.8cm): 4995 | MCI SHELF STOPPER ORDER REF. 4348 | STICKER PRINTY LINE MULTILINGUAL ORDER REF. FRONT: 86891 ORDER REF. BACK: 88745 | STICKER IMPRESSOR ORDER REF (ENGLISH) 84371 |
| | | | |
| STICKER TRODAT ORDER REF 10cmx2.5cm: 62541 ORDER REF 20cmx5cm: 62701 ORDER REF 53cmx13cm: 62540 ORDER REF 80cmx20cm: 62539 | FOLDER 'PRODUCT HIGHLIGHTS' ORDER REF. ENGLISH 4227 | FOLDER MCI A4 ORDER REF. ENGLISH 5094 | FOLDER PROFESSIONAL LINE ORDER REF. ENGLISH 86869 |
| | | | |
| FOLDER BIG PRINTY A4 ORDER REF. 9040 | FLYER BIG PRINTY A4 ORDER REF. ENGLISH 9049 | SWOP PAD OVERVIEW ORDER REF. 85841 | |
| | | | |
| FOLDER GOLDRING ORDER REF. 81708 | OVERLAY PROFESSIONAL LINE: 65955 OVERLAY PRINTY LINE: 70121 OVERLAY CLASSIC LINE: 78592 OVERLAY IMPRESSOR: 86350 | DISPLAY ACRYLIC (EMPTY) ORDER REF. 80311 | LEAFLET HOLDER (EMPTY) ORDER REF. 80312 |

| MODEL | Individual box | Blister packaging (availability upon request) | | | Multi-pack |
|---|----------------|---|-------|-------|---|
| | | single | 2 pcs | 3 pcs | |
| PROFESSIONAL LINE_ pages 9 - 15 | | | | | |
| ALL TYPES | X | | | | |
| 5203 | | X | | | 5203  5203/DB  |
| 5204 | | X | | | |
| 5206 | | X | | | |
| 5430 | | X | | | |
| 5440 | | X | | | |
| 5460 | | X | | | |
| 5430/L | | X | | | |
| 5117 | | X | | | |
| PRINTY LINE_ pages 16 - 24 | | | | | |
| ALL TYPES | X | | | | 10 |
| 4908 | | | | | |
| 4910 | | X | | | |
| 4911 | | X | | | |
| 4912 | | X | | | |
| 4913 | | X | | | |
| 4915 | | X | | | |
| 4750/L | | X | | | |
| 4810 | | X | | | |
| 4817 | | X | | | |
| 4820 | | X | | | |
| 4822 | | X | | | |
| 4846 | | X | | | |
| 4850/L | | X | | | |
| TYPOMATIC LINE_ pages 25 - 28 | | | | | |
| 4911_typo | | X | | | |
| 4912_typo | | X | | | |
| 4913_typo | | X | | | |
| 4928_typo | | X* | | | |
| 4927_typo | | X* | | | |
| 4755_typo | | X | | | |
| 4727_typo | | X* | | | |
| 46040_typo | | X | | | |
| 5253 | | X* | | | |
| 5435 | | X* | | | |
| 5465 | | X* | | | |
| SWOP-PAD REPLACEMENT PADS_ pages 29 - 31 | | | | | |
| ALL TYPES | | | | | 10 |
| including blister-packs | | | | | |
| 6/15 | | | X | X | |
| 6/50, 6/50/2 | | | X | X | |
| 6/53, 6/53/2 | | | X | X | |
| 6/55 | | | X | | |
| 6/56, 6/56/2 | | | X | X | |
| 6/57, 6/57/2 | | | X | | |
| 6/58 | | | X | X | |
| 6/58/2 | | | X | | |
| 6/4202/2 | | | X | | |
| 6/4204/2 | | | X | | |
| 6/4430/2 | | | X | | |
| 6/4610/2 | | | X | | |
| 6/44055 | | | X | X | |
| 6/46030 | | | X | X | |
| 6/46030/2 | | | X | | |
| 6/46040 | | | X | X | |
| 6/46145 | | | X | | |
| 6/4710 | | | X | | |
| * hanging pack with Euro slot | | | | | |

| MODEL | Individual box | Blister packaging (availability upon request) | | | Multi-pack |
|---|----------------|---|-------|-------|------------|
| | | single | 2 pcs | 3 pcs | |
| SWOP-PAD REPLACEMENT PADS_ pages 29 - 31 continued | | | | | |
| 6/4750, 6/4750/2 | | | X | X | |
| 6/4817 | | | X | X | |
| 6/4850, 6/4850/2 | | | X | X | |
| 6/4908 | | | X | | |
| 6/4910 | | | X | X | |
| 6/4911 | | | X | X | |
| 6/4912, 6/4912/2 | | | X | X | |
| 6/4913 | | | X | X | |
| 6/4915 | | | X | X | |
| 6/4916 | | | X | | |
| 6/4921 | | | X | | |
| 6/4922 | | | X | | |
| 6/4923 | | | X | | |
| 6/4924 | | | X | | |
| 6/4926 | | | X | | |
| 6/4926/2 | | | X | X | |
| 6/4927 | | | X | | |
| 6/4928 | | | X | | |
| 6/4929 | | | X | | |
| 6/4929/2 | | | X | X | |
| IMPRESSOR PRE-INKED_ pages 32 - 34 | | | | | |
| ALL TYPES | | | | | X indiv. |
| CLASSIC LINE_ pages 35 - 41 | | | | | |
| ALL TYPES | | | | | X indiv. |
| 2400 | X | | | | |
| 2410 | X | | | | |
| 2330/L | X | | | | |
| 2910 | X | | | | |
| 1000, 1010 | | X | | | |
| 1117 | | X | | | |
| 1546, 1556 | | X | | | |
| TWIN_ pages 42 - 43 | | | | | |
| ALL TYPES (plastic case) | X | | | | |
| MOBILE MARKER_ pages 44 - 45 | | | | | |
| 9412 | X | X | | | 18 |
| 9412_typo | | X | | | |
| STOCK STAMPS_ page 46 | | | | | |
| 4912 Office Printy | X | X | | | |
| P970 Stampstack | | X | | | 60 |
| SPECIAL STAMPS_ page 47 | | | | | |
| 4911_typo | | | | | |
| Clothing Marker | | X | | | |
| 4910 with key ring | X | | | | |
| 9011/9012 Vienna | X | | | | |
| 3610, 3620 and | | | | | |
| 3630 pocket seals | X | | | | |
| 5756 Auto. Nbr. M/C | X | | | | |
| ACCESSORIES_ page 48 | | | | | |
| Stamp rack | X | | | | |
| Stamp pad 9051 | X | | | | |
| Stamp pad 9052 | X | X | | | |
| Stamp pad 9053 | X | | | | |
| Stamp pad 9062 Micro | X | | | | |
| Stamp pad 9063 Micro | X | | | | |
| Stamp ink 7011 | | X | | | 10 |
| Stamp ink 7021 | | | | | 10 |
| Laser rubber | | | | | 10 |

TRODAT INTERNET SERVICES_



Trodat's uTypia internet software is designed to support its customers with their online selling. uTypia is a top-quality solution including many functions specially designed for the marking products business. Using uTypia, all you need is access to the Internet and an email account to sell your products. Thanks to its flexible applications and its broad range of products, uTypia meets all your demands and requirements. Please feel free to contact us about a custom-made solution for your Internet sales.



THE uTy SERVICES INCLUDE_

- **uTypia shop 3.0_**
The Trodat uTypia Shop is a quick way for customers to design the layout of their own stamps. Layout previews, draft designs and a logo library simplify this process. Printed forms and signs can also be sold via the uTypia shop. Price lists and product catalogues can be created for each individual user and the uTypia shop can be perfectly integrated into other systems.
- **uTypia shop light 2.0_**
The light version of the uTypia shop gives you the option of selling your products on the internet with only a small investment cost. The light shop is equipped with the basic functionality required for an Internet stamp shop, which now includes graphics and discount functions. uTypia light can be extended by additional modules up to the full version.
- **uTypia voucher 2.0_**
The voucher solution is based on a practical system. A voucher is incorporated into the stamp packaging. A code is quoted on this which enables the customer to access the voucher page on the Internet. This is where customers can design a textplate for their stamp on the Internet and submit it themselves. Preview layouts and graphics uploads simplify the ordering process.
- **uTypia page 2.0_**
You can present your company and its products on your own Homepage. In addition to the contacts page, your customers can also place orders for standard marking products. To create your Homepage, you do not need any Internet knowledge: just enter your message on a simple input form.

For further information, see: www.uTypia.com

The online typesetting solution



INTERNET SERVICES_

Having a presence and selling on the Internet is becoming more and more important. Trodat's professional Internet services are there to support you. **You can find more information on www.uTypia.com**

TRODAT SEAL_ FOR WINDOWS®

VISIBLE SECURITY FOR ELECTRONIC DOCUMENTS_



Your stamps now go digital and are more secure than ever before!

You can produce them from any Windows® application by pressing the command PDF documents and they will be protected by the Trodat Seal in the same step.

This provides proof to the receiver of the documents authenticity.

Trodat Seal – protection against identity theft and document fraud using the social accepted methods of stamping and signing.

| | | |
|---------------------------------|--|---|
| SEAL-LOGO | | Person, Legal entity (company, authority,...) |
| NAME OF SIGNATORY AND SIGNATURE | | information can be created as easily as a stamp text plate. |
| TIME OF SEAL AFFIXATION | | Identity (optional with Trodat Digital Pen) |
| SECURITY GRAPHIC | | Biometry included |
| CHECK LINK | | Time stamp |
| | | Document contents – securely locked |
| | | Indicates level of security |
| | | Receiver clicks on the line to validate the document |

TRODAT DIGITAL PEN_

Save on costs

With the **additional Trodat Digital Pen software** and a signature pad, even your own signature can now be digitalised with biometric security to protect your original documents. Give your electronic documents the personal touch!

System requirements: Windows 2000®, Acrobat Reader® and internet connection.

Instead of printing out on paper and signing: Sign the electronic document easily, quickly and securely.



FURTHER ADVANTAGES_

FOR SIGNATORIES

- **STAMP AND SIGNATURE_**
now available digitally. Visible marking on the screen and on printed documents.
- **BENEFITS YOU_**
in saving time and costs whilst working electronically.
- **JUST LIKE USING A STAMP_**
Authenticate, organise, validate, inform.

FOR RECEIVERS

- **VALIDATE THE ORIGIN_**
and verify the documents authenticity with the click of the mouse.
- **CHECKING_**
All you need for checking is an internet connection (no additional software). Even the paper original can be checked.



SEE MORE AT_ <http://seal.trodat.net>

EU Approval
The Trodat digital Sealing Technology uses internationally and technically recognised procedures for the use of an electronic signature for the protection of documents against forgery and to rule out identity theft. Trodat Digital Sealing is approved as an "advanced signature" complying with EU signature legislation from the registration authorities.

That's how easy it is to work with the Trodat Seal_

AS SIGNATORY AND/OR SENDER_



You have created a document (or returning to an existing PDF file) and want to "seal" it.

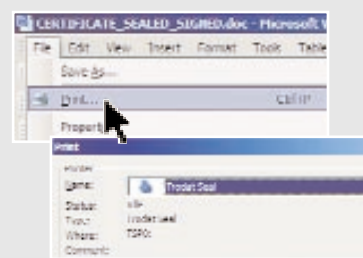

From your standard "Print" command, select the "Trodat Seal".



At the next click of the mouse, your document is changed into a PDF file. It cannot be separated from the Trodat Seal, which makes it into a permanent original.

AS RECEIVER_

YOU CAN NOW_

SEND THE "SEALED" DOCUMENT_
electronically by email or printed out and sent by post

STORE_
store it on your PC or server, print it out or file it



You have received a "sealed" document by email and you want to check that it has not been changed or forged by a third party:



Just click on the validation link for the digital seal on the document.



A few seconds later you will receive a certificate, which provides reliable information concerning both the authenticity of the document and the identity of the signatory.

TROTEC LASER ENGRAVING TECHNOLOGY_



Over the past few years, laser technology has set out to conquer the stamp industry and Trotec products have become the world's best-selling laser systems for stamp manufacturers, thanks to our innovative and reliable solutions.



YOU CAN BENEFIT FROM_



- **Individual items or series_**

Whether you manufacture A4-plates or individual stamps, Trotec can provide you with the best possible solutions for all your needs.



- **Maximum productivity_**

The fastest engraving speeds available and minimal maintenance ensure that your Trotec lasers make profits for you.



- **Environment conscious production_**

Production is characterised by a direct link between the computer and the plate, thus avoiding intermediate materials and waste products such as foils, stencils or chemicals.



- **High degree of flexibility_**

Laser systems can be used for a series of applications such as plaques, promotional items, displays, etc. As a result, you will see benefits even faster when using your Trotec laser.

- **Low-cost production method_**

Reasonable Laser technology offers you good value for money compared to other manufacturing methods as it ensures low investment cost with the best possible profit margins.